



ZD-N103

.材质/Material: 铁 (Iron)  
 .表面处理/Finish: 镀铬、哑黑、金色  
 chrome plated, matte black, gold  
 .高度/height: 130、150、170mm  
 .底胶/Bottom rubber : 白胶 White rubber



ZD-N110

.材质/Material: Iron(铁)  
 .高度/height:130 mm 厚度/Thickness:7.5mm  
 .表面处理/Finish:镀铬、黑色 chrome plated, black  
 .底胶/Bottom rubber : 黑胶 black rubber



ZD-N114

.材质/Material: Iron(铁)  
 .高度/height:130、150、170、200 mm  
 .表面处理/Finish: 黑色、镀铬、白色、金色 black、  
 chrome plated, white, Gold  
 .底胶/Bottom rubber : 黑胶 black rubber



ZD-N114-A

.材质/Material: Iron(铁)  
 .高度/height:140、160 mm  
 .表面处理/Finish: 黑色、镀铬、白色、金色 black、  
 chrome plated, white, Gold  
 .底胶/Bottom rubber : 黑胶 black rubber



ZD-N112

.材质/Material: Iron(铁)  
 .高度/height:120、150、180、220、250、300、  
 350、420、450 mm  
 .厚度/Thickness:8、9mm  
 .表面处理/Finish:镀铬、黑色 chrome plated, black  
 .底胶/Bottom rubber : 黑胶 black rubber



ZD-N112-A

.材质/Material: Iron(铁)  
 .高度/height:160mm 厚度/Thickness:9mm  
 .表面处理/Finish:镀铬、黑色、金色 chrome plated, black, gold  
 .底胶/Bottom rubber : 黑胶 black rubber



ZD-N115

.材质/Material: Iron(铁)  
 .边长/Length of a side: 130\*130mm  
 .厚度/Thickness:2.0mm 高度/height:50mm  
 .表面处理/Finish: 镀铬 chrome plated  
 .底胶/Bottom rubber : 黑胶 black rubber



ZD-N116斜/百锥脚斜度77度

.规格/size: 18\*32\*100, 18\*32\*120, 180\*32\*150, 18\*32\*200  
 、18\*32\*250, 18\*32\*350, 18\*32\*400, 18\*32\*700、  
 .材质/Material: Iron(铁)  
 .表面处理/Finish: 黑色、镀铬、金色、木纹色、黑配金色 black、  
 chrome plated, gold, wooden color, black with gold  
 .底胶/Bottom rubber : 黑胶 Black rubber



ZD-N113

.材质/Material: Iron(铁)  
 .高度/height:100、120 mm  
 .厚度/Thickness:4.0、4.5mm  
 .表面处理/Finish:镀铬、玫瑰金 chrome plated, rose gold  
 .底胶/Bottom rubber : 白胶 White rubber



ZD-N116-A1斜/直锥脚斜度80度

.规格/size: 38\*25\*500, 38\*25\*550, 38\*25\*600、  
 38\*25\*650, 38\*25\*710mm  
 .材质/Material: Iron(铁)  
 .表面处理/Finish: 哑黑、沙黑色、木纹色、黑配金色  
 Matte black, Sand black, wooden color, black with gold  
 .底胶/Bottom rubber : 黑胶 Black rubber





ZD-N116-A

.规格/size: 16\*25\*100, 16\*25\*120, 16\*32\*150, 16\*32\*170, 16\*32\*200, 16\*32\*250, 16\*32\*350,  
.材质/Material: Iron(铁)  
.表面处理/Finish: 镀铬、哑黑、钛金  
chrome plated, Matte black, Titanium Gold  
.底胶/Bottom rubber : 白胶 White rubber



ZD-N116-B

.规格/ Size: 18\*32\*100, 18\*32\*120, 18\*32\*150, 18\*32\*170, 18\*32\*200, 18\*32\*300, 18\*32\*350, 18\*32\*450  
.材质/Material: Iron(铁)  
.表面处理/Finish: 钛金、哑黑  
Titanium Gold, matte black  
.底胶/Bottom rubber : 白胶 white rubber



ZD-N118-A

.高度/height: 80, 100, 120, 150, 170 mm  
.厚度/thickness: 2.0mm  
.材质/Material: Iron(铁)  
.表面处理/Finish: 镀铬、黑色、chrome plated, black  
.底胶/Bottom rubber : 白胶 white rubber



ZD-N117

.高度/ height: 170mm  
.材质/Material: Iron(铁)  
.表面处理/Finish: 镀铬、黑色、chrome plated, black,  
.底胶/Bottom rubber : 白胶 white rubber



ZD-N119

.高度/height: 130, 150, 170 mm  
.厚度/thickness: 4.0mm  
.材质/Material: Iron(铁)  
.表面处理/Finish: 镀铬、黑色、金色 chrome plated, black, gold,  
.底胶/Bottom rubber : 白胶 white rubber



ZD-N120

.规格/size: H150mm  
.管厚/Tube Thickness: 1.0mm  
.材质/Material: Iron(铁)  
.表面处理/Finish: 镀铬 chrome plated



ZD-N117-A

.高度/height: 110, 150, 180mm  
.材质/Material: Iron(铁)  
.表面处理/Finish: 镀铬、黑色、金色  
chrome plated, black, Gold  
.底胶/Bottom rubber : 白胶 white rubber



ZD-N118

.高度/height: 80, 100, 120, 150mm  
.厚度/thickness: 1.8mm  
.材质/Material: Iron(铁)  
.表面处理/Finish: 镀铬、黑色、金色  
chrome plated, black, Gold  
.底胶/Bottom rubber : 白胶 white rubber



ZD-N121

.高度/height: 175mm  
.材质/Material: Iron(铁)  
.表面处理/Finish: 沙黑 Sand black





ZD-N122(长边三叉平脚)

.高度/height: 120、150、190、250mm  
.厚度/thickness: 2.0、2.3、2.5mm  
.材质/Material: Iron(铁)  
.表面处理/Finish: 哑黑、镀铬、金色 Matte black、Chrome plated、gold  
.底胶/Bottom rubber : 白胶 white rubber



ZD-N122-B(长边三叉平脚)

.高度/height: 120、150、180mm  
.厚度/thickness: 2.0、2.5mm  
.材质/Material: Iron(铁)  
.表面处理/Finish: 哑黑、镀铬、金色 Matte black、Chrome plated、gold



ZD-N126-2

.规格/size: :H150\*L800\*T10 mm  
.顶板尺寸/Size of Top plate:80\*800\*T6.0mm  
.材质/Material: Iron(02款大铁脚)  
.表面处理/Finish:黑 Black



ZD-N126-3

.规格/size: :H170\*L800\*T10mm  
.顶板尺寸/Size of Top plate:80\*800\*T6.0mm  
.材质/Material: Iron(03款大铁脚)  
.表面处理/Finish:黑 Black



ZD-N122-C

.高度/height: 300、350、400、450、600、720mm  
.厚度/thickness: 2.5mm  
.材质/Material: Iron(铁)  
.表面处理/Finish: 哑黑、镀铬、金色 Matte black、Chrome plated、gold  
.底胶/Bottom rubber : 白胶 white rubber



ZD-N124

.规格/size: H150\*T 2.0mm  
.材质/Material: Iron(铁)  
.表面处理/Finish: 哑黑、镀铬、金色 Matte Black、Chrome plated、gold



ZD-N126-4(A)

.规格/size: H230\*L750\*T10mm  
.顶板尺寸/Size of Top plate:800\*60\*10mm  
.材质/Material: Iron(04款大铁脚)  
.表面处理/Finish:黑 Black



ZD-N126-4 (B)

.规格/size: H230\*L750\*T10 MM  
.顶板尺寸/Size of Top plate:80\*50\*10MM  
.材质/Material: Iron(04款大铁脚)  
.表面处理/Finish:黑 Black



ZD-N124-A

.规格/size: H150\*T1.0mm  
.材质/Material: Iron(铁)  
.表面处理/Finish: 哑黑、镀铬、金色 Matte Black、Chrome plated、gold



ZD-N126-1

.规格/size: :H150\*L800\*T10 mm  
.顶板尺寸/Size of Top plate:80\*600\*T6.0mm  
.材质/Material: Iron(01款大铁脚)  
.表面处理/Finish:黑 Black



ZD-N126-5

.规格/size: H150\*L920\*T10MM  
.顶板尺寸/Size of Top plate:80\*80\*4.0MM  
.材质/Material: Iron(05款大铁脚)  
.表面处理/Finish:黑 Black





ZD-N126-6

.规格/size: H230\*900\*T10MM  
.顶板尺寸/Size of Top plate:80\*700\*6.0MM  
.材质/Material: Iron(06款大铁脚)  
.表面处理/Finish:黑 Black



ZD-N126-7(A)

.规格/size: H130\*800\*T10MM  
.顶板尺寸/Size of Top plate:80\*600\*6.0MM  
.材质/Material: Iron(07款大铁脚)  
.表面处理/Finish:黑 Black



ZD-N126-10

.规格/size: H130\*900\*10MM  
.顶板尺寸/Size of Top plate:80\*80\*T6.0MM  
.材质/Material: Iron(10款大铁脚)  
.表面处理/Finish:黑 Black



ZD-N126-11

.规格/size: H120\*850\*10MM  
.顶板尺寸/Size of Top plate:80\*800\*T6.0MM  
.材质/Material: Iron(11款大铁脚)  
.表面处理/Finish:黑 Black



ZD-N126-7(B)

.规格/size: H170\*800\*10 mm  
.顶板尺寸/Size of Top plate:80\*80\*6.0mm  
.材质/Material: Iron(07款大铁脚)  
.表面处理/Finish:黑 Black



ZD-N126-12

.规格/size: H160\*850\*10MM  
.顶板尺寸/Size of Top plate:80\*600\*T6.0MM  
.材质/Material: Iron(12款大铁脚)  
.表面处理/Finish:黑 Black



ZD-N126-13

.规格/size: H120\*L350\*10MM  
.顶板尺寸/Size of Top plate:250\*60\*T6.0MM  
.材质/Material: Iron(13款大铁脚)  
.表面处理/Finish:黑 Black



ZD-N126-8

.规格/size: H170\*900\*10 mm  
.顶板尺寸/Size of Top plate:80\*700\*6.0mm  
.材质/Material: Iron(08款大铁脚)  
.表面处理/Finish:黑 Black



ZD-N126-9

.规格/size: H150\*900\*10MM  
.顶板尺寸/Size of Top plate:80\*600\*T4.0MM  
.材质/Material: Iron(09款大铁脚)  
.表面处理/Finish:黑 Black



ZD-N126-14

.规格/size: H110\*L650\*10MM  
.顶板尺寸/Size of Top plate:380\*60\*T6.0MM  
.材质/Material: Iron(14款大铁脚)  
.表面处理/Finish:黑 Black



ZD-N126-15

.规格/size: H90\*180\*10mm  
.顶板尺寸/Size of Top plate:80\*80\*T6.0mm  
.材质/Material: Iron(15款大铁脚)  
.表面处理/Finish:黑 Black





ZD-N127

.材质/Material: Iron(铁)  
 .规格/size: H80, 100, 120, 150, 200, 250, 300, 350, 450, 500, 600, 650 mm  
 .顶板尺寸/size of Top plate: 110\*110\*3.0mm  
 .表面处理/Finish: 哑黑、镀铬、金色 Matte Black, Chrome plated, gold



ZD-N127-A

.材质/Material: Iron(铁)  
 .规格/size: H80, 100, 120, 150, 200, 250, 300, 350 mm  
 .表面处理/Finish: 哑黑、镀铬、金色 Matte Black, Chrome plated, gold



ZD-N130

.材质/Material: 铁 iron  
 .表面处理/Finish: 镀铬、黑、chrome plated, Black  
 .高度/height: 150, 200mm  
 .底胶/Bottom rubber: 黑胶 black rubber



ZD-N131

.材质/Material: 铁 iron  
 .表面处理/Finish: 哑黑色、镀铬、金色 Matte black, chrome plated, gold  
 .高度/height: 130, 150mm  
 .厚度/thickness: 2.5mm  
 .底胶/Bottom rubber: 黑胶 black rubber



ZD-N128

.规格/size: H150\*T3.0, 170\*3.0mm  
 .材质/Material: Iron(铁)  
 .表面处理/Finish: 哑黑、镀铬、金色 Matte Black, Chrome plated, gold



ZD-N131-A

.材质/Material: 铁 iron  
 .表面处理/Finish: 哑黑色、镀铬、金色 Matte black, chrome plated, gold  
 .高度/height: 120, 150mm  
 .厚度/thickness: 2.5mm  
 .底胶/Bottom rubber: 黑胶 black rubber



ZD-N131-B

.材质/Material: 铁 iron  
 .表面处理/Finish: 哑黑色、镀铬、金色 Matte black, chrome plated, gold  
 .高度/height: 120mm  
 .厚度/thickness: 3.0mm  
 .底胶/Bottom rubber: 黑胶 black rubber



ZD-N129

.规格/size: 50\*100, 50\*120, 50\*150, 50\*170mm  
 .材质/Material: Iron(铁)  
 .顶板尺寸/Size of Top plate: 70\*70mm  
 .表面处理/Finish: 柚木棕、橡木黄、红橡木、樱桃木、胡桃木、黑胡桃色 Teak brown, oak yellow, red oak, cherry wood, walnut, black walnut color



ZD-N131-C

.材质/Material: 铁 iron  
 .表面处理/Finish: 哑黑色、镀铬、金色 Matte black, chrome plated, gold  
 .高度/height: 150mm  
 .厚度/thickness: 4.0mm  
 .底胶/Bottom rubber: 黑胶 black rubber



ZD-N132

.材质/Material: 铁 iron  
 .表面处理/Finish: 哑黑色、镀铬、金色 Matte black, chrome plated, gold  
 .高度/height: 120, 150, 180mm  
 .厚度/thickness: 1.5, 2.0, 2.5mm  
 .底胶/Bottom rubber: 白胶 white rubber



ZD-N133-A

.材质/Material: 铁 iron  
.表面处理/Finish: 黑色 black,  
.高度/height: 160mm  
.厚度/thickness: 4.0mm



ZD-N133-B

.材质/Material: 铁 iron  
.表面处理/Finish: 黑色 black,  
.高度/height: 160mm  
.厚度/thickness: 4.0mm



ZD-N137

.材质/Material: 铁 iron  
.表面处理/Finish: 镀铬 chrome plated  
.高度/height: 120mm  
.厚度/thickness: 3.0mm  
.底胶/Bottom rubber : 白胶 white rubber



ZD-N139 A/B

.材质/Material: stainless steel  
.表面处理/Finish: 金色 Gold  
.高度/height: 115, 125mm  
.厚度/thickness: 3.0mm  
.顶板线径/Diameter of top plate : 90, 100mm



ZD-N135

.材质/Material: 铁 iron  
.表面处理/Finish: 黑色、镀铬、金色、黑配金 black, chrome plated, gold, black white gold  
.高度/height: 130, 150, 180, 200mm  
.管的厚度/pipe thickness: 1.2mm  
.底胶/Bottom rubber : 黑胶 black rubber



ZD-N135-B

.材质/Material: 铁 iron  
.表面处理/Finish: 黑色、镀铬、金色、black, chrome plated, gold  
.高度/height: 130, 150, 180, 200, 220mm  
.管的厚度/pipe thickness: 1.0mm  
.底胶/Bottom rubber : 黑胶 black rubber



ZD-N140-A/B

.材质/Material: 不锈钢 Stainless steel  
.表面处理/Finish: 金色 gold  
.规格/size H175\*L175, H160\*L165\*L135mm

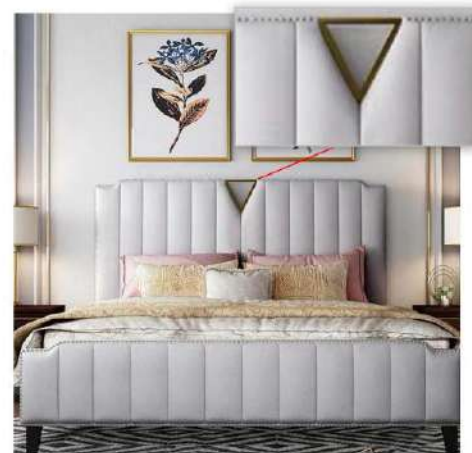

ZD-N135-C

.材质/Material: 铁 iron  
.表面处理/Finish: 哑黑色、镀铬、金色、黑配金 Matte black, chrome plated, gold, black white gold  
.高度/height: 130, 150, 180mm  
.管的厚度/pipe thickness: 1.5mm  
.底胶/Bottom rubber : 黑胶 black rubber



ZD-N140-C

.材质/Material: 不锈钢 Stainless steel  
.表面处理/Finish: 金色 gold  
.规格/size H40\*L225mm



ZD-N141-A

.材质/Material: 铁 iron  
.表面处理/Finish: 黑配金 Black and Golden  
.高度/Height: 230mm  
.顶板尺寸: Size of top plate: 80\*60\*T4.5mm





ZD-N141-B

.材质/Material: 铁 iron  
.表面处理/Finish: 黑配金 Black and Golden  
.高度/Height: 185mm



ZD-N141-C

.材质/Material: 铁 iron  
.表面处理/Finish: 黑配金 Black and Golden  
.高度/Height: 255mm  
.顶板尺寸: Size of top plate: L75\*L75\*T3.5mm



ZD-N145-A

.材质/Material: 不锈钢 Stainless steel  
.表面处理/Finish: 金色 gold  
.高度/Height: 185mm  
.顶板尺寸: Size of top plate: T3.0\*L90mm  
.底胶/Bottom Rubber: 黑胶 Black rubber



ZD-N145-B

.材质/Material: 不锈钢 Stainless steel  
.表面处理/Finish: 金色 gold  
.高度/Height: 300mm  
.顶板尺寸: Size of top plate: T2.5\*L155mm  
.底胶/Bottom Rubber: 白胶 White rubber



ZD-N142-A/B

.材质/Material: 不锈钢 Stainless steel  
.表面处理/Finish: 金色 gold  
.高度/Height: 125、150mm  
.顶板尺寸: Size of top plate: T3.0\*L75\*L75mm



ZD-N143-A

.材质/Material: 不锈钢 Stainless steel  
.表面处理/Finish: 金色 gold  
.高度/Height: 320mm  
.顶板尺寸: Size of top plate: T3.0\*L80\*L80mm  
.底胶/Bottom Rubber: 白胶 White rubber



ZD-N146-A

.材质/Material: 不锈钢 Stainless steel  
.表面处理/Finish: 黑色、金色、Black、gold  
.规格/Size: H155\*T2.5mm  
.宽度/Width: 270mm  
.底胶/Bottom Rubber: 白胶 White rubber



ZD-N147-A

.材质/Material: 不锈钢 Stainless steel  
.表面处理/Finish: 金色 Gold  
.高度/Height: 240mm  
.顶板厚度/Thickness of top plate: 3.5mm  
.底胶/Bottom rubber: 白胶 White rubber



ZD-N143-B

.材质/Material: 不锈钢 Stainless steel  
.表面处理/Finish: 金色 gold  
.高度/Height: 195mm  
.顶板尺寸: Size of top plate: T5.0\*L70\*L60mm  
.底胶/Bottom Rubber: 白胶 White rubber



ZD-N144-A/B

.材质/Material: 不锈钢 Stainless steel  
.表面处理/Finish: 金色 gold  
.总高度/Total Height: 265mm  
.底胶/Bottom Rubber: 白胶 White rubber



ZD-N148

.材质/Material: 铁 iron  
.表面处理/Finish: 黑配金 Black and golden  
.总高度/Total height: 300mm  
.底部到铁片高度/Bottom to plate height: 180mm  
.底胶/Bottom rubber: 黑胶 black rubber







ZD-N149

.材质/Material: 铁 Iron  
.表面处理/Finish: 黑色、镀铬 black、 Chrome plated  
.高度/Height: 100mm 厚度/Thickness: 2.0m  
.底胶/Bottom rubber: 白胶 White rubber



ZD-N150

.材质/Material: 铁 iron  
.表面处理/Finish: 金色、黑色、镀铬 Gold、 Chrome plated、 black  
.高度/height: 150、195、250 mm  
.厚度/Thickness: 3.0mm  
.底胶/Bottom rubber: 白胶 white rubber



ZD-N154

.材质/Material: 铁 iron  
.表面处理/Finish: 金色、黑色、镀铬 Gold、 Chrome plated、 black  
.高度/height: 130、150、180、200mm  
.底胶/Bottom rubber: 黑胶 black rubber

ZD-N系列



ZD-N150-B

.材质/Material: 铁 iron  
.表面处理/Finish: 金色、黑色、镀铬 Gold、 black、 Chrome plated  
.高度/height: 150、195 mm  
.厚度/Thickness: 3.0mm  
.底胶/Bottom rubber: 白胶 white rubber



ZD-N151

.材质/Material: 铁 iron  
.表面处理/Finish: 金色、黑色、镀铬 Gold、 black、 Chrome plated  
.高度/height: 120、150 mm  
.底胶/Bottom rubber: 白胶 white rubber



ZD-N154-A(焊圆球)

.材质/Material: 铁 iron  
.表面处理/Finish: 金色、黑色、镀铬 Gold、 Chrome plated、 black  
.高度/height: 150、180mm  
.底胶/Bottom rubber: 黑胶 black rubber



ZD-N154-B

.材质/Material: 铁 iron  
.表面处理/Finish: 金色、黑色、镀铬 Gold、 Chrome plated、 black  
.高度/height: 150、180mm  
.底胶/Bottom rubber: 黑胶 black rubber



ZD-N153

.材质/Material: 铁 iron  
.表面处理/Finish: 哑黑 Matte black  
.高度/height: 150、170mm  
.底胶/Bottom rubber: 黑胶 black rubber



ZD-N154-C

.材质/Material: 铁 iron  
.表面处理/Finish: 金色、黑色、镀铬 Gold、 black Chrome plated  
.高度/height: 150、180 mm  
.底胶/Bottom rubber: 黑胶 black rubber



ZD-N155-A

.材质/Material: 铁 iron  
.表面处理/Finish: 金色 Gold  
.高度/height: 130 mm 厚度/Thickness: 1.8mm  
.底胶/Bottom rubber: 白胶 white rubber

ZD-N系列



ZD-N155-B

.材质/Material: 铁 iron  
 .表面处理/Finish: 金色、玫瑰金、白色、青古  
 Gold, Rose Gold, white, bronze  
 .高度/height: 130 mm 厚度/Thickness:1.8mm  
 .底胶/Bottom rubber : 白胶 white rubber



ZD-N155-C

.材质/Material: 铁 iron  
 .表面处理/Finish: 金色 Gold  
 .高度/height: 130 mm 厚度/Thickness:1.8mm  
 .底胶/Bottom rubber : 白胶 white rubber



ZD-N155-D

.材质/Material: 铁 iron  
 .表面处理/Finish: 金色、玫瑰金、白色、青古、红古色  
 Gold, rose gold, white, bronze, copper  
 .高度/height: 130mm 厚度/Thickness:1.8mm  
 .底胶/Bottom rubber : 白胶 white rubber



ZD-N155-E

.材质/Material: 铁 iron  
 .表面处理/Finish: 金色 Gold  
 .高度/height: 130 mm 厚度/Thickness:1.8mm  
 .底胶/Bottom rubber : 白胶 white rubber



ZD-N155-F

.材质/Material: 铁 iron  
 .表面处理/Finish: 金色、红古色 gold, copper  
 .高度/height: 130mm 厚度/Thickness:1.8mm  
 .底胶/Bottom rubber : 白胶 white rubber



ZD-N156

.材质/Material: 铁 iron  
 .表面处理/Finish: 镀铬、玫瑰金、哑黑、青古、红古色  
 chrome plated, rose gold, Matte black, bronze, copper  
 .高度/height: 130、150、180、200、250 mm  
 .底胶/Bottom rubber : 黑胶 black rubber

ZD-N系列



ZD-N157

.材质/Material: 铁 iron  
 .表面处理/Finish: 金色、镀铬、玫瑰金、哑黑、青古  
 Gold chrome plated, rose gold, Matte black, bronze  
 .高度/height: 150mm  
 .底胶/Bottom rubber : 黑胶 black rubber



ZD-N157-A

.材质/Material: 铁 iron  
 .表面处理/Finish: 金色、黑色、镀铬 gold, black,  
 Chrome plated,  
 .高度/height: 116mm  
 .底胶/Bottom rubber : 黑胶 black rubber



ZD-N158

.材质/Material: 铁 iron  
 .表面处理/Finish: 镀铬、玫瑰金、哑黑、青古、金色  
 chrome plated, rose gold, Matte black, bronze, gold  
 .高度/height: 190mm  
 .底胶/Bottom rubber : 黑胶 black rubber



ZD-N159

.材质/Material: 铁 iron  
 .表面处理/Finish: 金色、哑黑、镀铬 Gold,  
 matte black, Chrome plated  
 .高度/height: 150、170、190mm  
 .底胶/Bottom rubber : 黑胶 black rubber





ZD-N161

.材质/Material: 铁 iron  
.表面处理/Finish: 哑黑、镀铬、金色 Matte black, chrome plated, gold  
.高度/height: 130、150、180、200mm  
.底胶/Bottom rubber : 黑胶 black rubber



ZD-N161-A

.材质/Material: 铁 iron  
.表面处理/Finish: 哑黑、镀铬、金色 Matte black, chrome plated, gold  
.高度/height: 130、150、180、200mm  
.底胶/Bottom rubber : 白胶 white rubber



ZD-N162-C2

.材质/Material: 铁 iron  
.表面处理/Finish: 哑黑、镀铬、金色 Matte black, chrome plated, gold  
.高度/height: 150、180、210 mm  
.底胶/Bottom rubber : 黑胶 Black rubber



ZD-N系列

ZD-N163-A

.材质/Material: 铁 iron  
.表面处理/Finish: 哑黑 Matte black  
.高度/height: 150mm  
.底胶/Bottom rubber : 黑胶 Black rubber



ZD-N162-A

.材质/Material: 铁 iron  
.表面处理/Finish: 哑黑、镀铬、金色 Matte black, chrome plated, gold  
.高度/height: 150、175mm  
.底胶/Bottom rubber : 黑胶 Black rubber



ZD-N162-B

.材质/Material: 铁 iron  
.表面处理/Finish: 哑黑、镀铬、金色 Matte black, chrome plated, gold  
.高度/height: 160、175mm  
.底胶/Bottom rubber : 黑胶 Black rubber



ZD-N163-B

.材质/Material: 铁 iron  
.表面处理/Finish: 哑黑 Matte black  
.高度/height: 120、150、180mm  
.底胶/Bottom rubber : 黑胶 Black rubber



ZD-N162-B2(带花胶)

.材质/Material: 铁 iron  
.表面处理/Finish: 哑黑、镀铬、金色 Matte black, chrome plated, gold  
.高度/height: 160、175mm  
.底胶/Bottom rubber : 黑胶 Black rubber



ZD-N162-C

.材质/Material: 铁 iron  
.表面处理/Finish: 哑黑、镀铬、金色 Matte black, chrome plated, gold  
.高度/height: 160、180、210mm  
.底胶/Bottom rubber : 黑胶 Black rubber



ZD-N164

.材质/Material: 铁 iron  
.表面处理/Finish: 哑黑、镀铬、金色 Matte black, chrome plated, gold  
.高度/height: 120、150、180、200mm  
.底胶/Bottom rubber : 黑胶 Black rubber



ZD-N164-A

.材质/Material: 铁 iron  
.表面处理/Finish: 哑黑、镀铬、金色 Matte black, chrome plated, gold  
.高度/height: 130、150mm  
.底胶/Bottom rubber : 白胶 white rubber



ZD-N系列



ZD-N165

.材质/Material: 铁 iron  
.表面处理/Finish: 玫瑰金 rose golden  
.高度/height: 130, 150, 160, 180 mm  
.厚度/Thickness: 2.5mm  
.底胶/Bottom rubber: 白胶 white rubber



ZD-N166

.材质/Material: 铁 iron  
.表面处理/Finish: 哑黑, 镀铬, 金色 Matte black, chrome plated, gold  
.高度/height: 150mm  
.底胶/Bottom rubber: 白胶 White rubber



ZD-N168-A

.材质/Material: 铁 iron  
.表面处理/Finish: 哑黑, 镀铬, 金色 Matte black, chrome plated, gold  
.高度/height: 120, 150, 170mm  
.厚度/thickness: 2.5mm  
.底胶/Bottom rubber: 白胶 White rubber



ZD-N168-B

.材质/Material: 铁 iron  
.表面处理/Finish: 哑黑, 镀铬, 金色 Matte black, chrome plated, gold  
.高度/height: 120, 150, 180mm  
.厚度/thickness: 2.5mm  
.底胶/Bottom rubber: 白胶 White rubber



ZD-N169

.材质/Material: 铁 iron  
.表面处理/Finish: 镀铬 chrome plated  
.高度/height: 90mm  
.底胶/Bottom rubber: 黑胶 black rubber



ZD-N170

.材质/Material: 201不锈钢 201Stainless steel  
.表面处理/Finish: 金色 gold  
.高度/height: 80, 100, 120, 150 mm  
.底胶/Bottom rubber: 黑胶 black rubber



ZD-N171-A

.材质/Material: 铁 iron  
.表面处理/Finish: 哑黑, 镀铬, 金色 Matte black, chrome plated, gold  
.高度/height: 150 mm 厚度/thickness: 8.0mm  
.底胶/Bottom rubber: 黑胶 black rubber



ZD-N171-B

.材质/Material: 铁 iron  
.表面处理/Finish: 哑黑, 镀铬, 金色 Matte black, chrome plated, gold  
.高度/height: 150 mm 厚度/thickness: 2.8mm  
.底胶/Bottom rubber: 黑胶 black rubber



ZD-N172

.材质/Material: 铁 iron  
.表面处理/Finish: 哑黑, 镀铬, 金色 Matte black, chrome plated, gold  
.高度/height: 180mm  
.底胶/Bottom rubber: 黑胶 black rubber



ZD-N172-A

.材质/Material: 铁 iron  
.表面处理/Finish: 哑黑, 镀铬, 金色 Matte black, chrome plated, gold  
.高度/height: 130, 150, 180mm  
.厚度/thickness: 1.5mm  
.底胶/Bottom rubber: 黑胶 black rubber



ZD-N172-B

.材质/Material: 铁 iron  
.表面处理/Finish: 哑黑, 金色 Matte black, gold  
.高度/height: 130, 150, 180mm  
.底胶/Bottom rubber: 黑胶 black rubber

ZD-N系列



ZD-N172-C

.材质/Material: 铁 iron  
.表面处理/Finish: 哑黑、镀铬、金色 Matte black, chrome plated, gold  
.高度/height: 190 mm  
.厚度/thickness: 1.5mm  
.底胶/Bottom rubber : 黑胶 black rubber



ZD-N172-D

.材质/Material: 铁 iron  
.表面处理/Finish: 哑黑、镀铬、金色 Matte black, chrome plated, gold  
.高度/height: 190 mm  
.厚度/thickness: 1.5mm  
.底胶/Bottom rubber : 黑胶 black rubber



ZD-N173

.材质/Material: 铁 iron  
.表面处理/Finish: 哑黑、镀铬、金色 Matte black, chrome plated, gold  
.高度/height: 150、180、220 mm  
.底胶/Bottom rubber : 黑胶 black rubber



ZD-N173-A

.材质/Material: 铁 iron  
.表面处理/Finish: 哑黑、镀铬、金色 Matte black, chrome plated, gold  
.高度/height: 160、180、200、250mm  
.底胶/Bottom rubber : 黑胶 black rubber



ZD-N173-F

.材质/Material: 铁 iron  
.表面处理/Finish: 哑黑、镀铬、金色 Matte black, chrome plated, gold  
.高度/height: 150、180 mm  
.底胶/Bottom rubber : 白胶 white rubber



ZD-N173-G

.材质/Material: 铁 iron  
.表面处理/Finish: 哑黑、镀铬、金色 Matte black, chrome plated, gold  
.高度/height: 150 mm  
.底胶/Bottom rubber : 白胶 white rubber



ZD-N174

.材质/Material: 铁 iron  
.表面处理/Finish: 哑黑、Matte black  
.高度/height: 165mm  
.底胶/Bottom rubber : 白胶 white rubber



ZD-N173-C

.材质/Material: 铁 iron  
.表面处理/Finish: 哑黑、镀铬、金色 Matte black, chrome plated, gold  
.高度/height: 150、180、200mm  
.底胶/Bottom rubber : 黑胶 black rubber



ZD-N173-D

.材质/Material: 铁 iron  
.表面处理/Finish: 哑黑、镀铬、金色 Matte black, chrome plated, gold  
.高度/height: 100、120、150、180、200 mm  
.底胶/Bottom rubber : 黑胶 black rubber



ZD-N175

.材质/Material: 铁 iron  
.表面处理/Finish: 哑黑、Matte black  
.高度/height: 150mm 厚度/Thickness: 2.5mm  
.底胶/Bottom rubber : 白胶 white rubber



ZD-N176

.材质/Material: 铁 iron  
.表面处理/Finish: 哑黑、镀铬、金色 Matte black, chrome plated, gold  
.高度/height: 130、150、170mm  
.底胶/Bottom rubber : 白胶 white rubber



ZD-N系列



ZD-N177

.材质/Material: 铁 iron  
.表面处理/Finish: 哑黑、镀铬、金色 Matte black, chrome plated, gold  
.高度/Height: 150、170mm  
.底胶/Bottom rubber: 白胶 white rubber



ZD-N178

.材质/Material: Iron(铁)  
.表面处理/Finish: 镀铬、黑色、金色、chrome plated, black, gold,  
.高度/Height: 140mm  
.底胶/Bottom rubber: 黑胶 Black rubber



ZD-N180-C

.材质/Material: Iron(铁)  
.表面处理/Finish: 镀铬、黑色、金色、chrome plated, black, gold,  
.高度/Height: 150、180mm 厚度/thickness: 2.5mm  
.底胶/Bottom rubber: 白胶 white rubber

ZD-N系列



ZD-N181-A

.材质/Material: Iron(铁)  
.表面处理/Finish: 镀铬、黑色、金色、chrome plated, black, gold,  
.高度/Height: 85mm  
.底胶/Bottom rubber: 白胶 white rubber



ZD-N178-A

.材质/Material: Iron(铁)  
.表面处理/Finish: 枪黑配金 Gun Black with gold  
.高度/Height: 140mm  
.底胶/Bottom rubber: 黑胶 Black rubber



ZD-N181-B/C

.材质/Material: Iron(铁)  
.表面处理/Finish: 镀铬、黑色、金色、chrome plated, black, gold,  
.高度/Height: 85、140mm  
.底胶/Bottom rubber: 白胶 white rubber



ZD-N182

.材质/Material: Iron(铁)  
.表面处理/Finish: 镀铬、黑色、金色、chrome plated, black, gold,  
.高度/Height: 120、150、170、180mm  
.底胶/Bottom rubber: 白胶 white rubber



ZD-N179

.材质/Material: Iron(铁)  
.表面处理/Finish: 镀铬、黑色、金色、chrome plated, black, gold,  
.高度/Height: 130、150、180mm  
.底胶/Bottom rubber: 黑胶 Black rubber



ZD-N180-A

.材质/Material: Iron(铁)  
.表面处理/Finish: 镀铬、黑色、金色、chrome plated, black, gold,  
.高度/Height: 170mm 厚度/thickness: 2.0mm  
.底胶/Bottom rubber: 白胶 white rubber



ZD-N182-B

.材质/Material: Iron(铁)  
.表面处理/Finish: 镀铬、黑色、金色、玫瑰金、青铜 chrome plated, black, gold, Rose Gold, bronze  
.高度/Height: 120、150 mm  
.底胶/Bottom rubber: 白胶 white rubber



ZD-N182-C

.材质/Material: Iron(铁)  
.表面处理/Finish: 镀铬、黑色、金色 chrome plated, black, gold  
.高度/Height: 120、150 mm  
.底胶/Bottom rubber: 白胶 white rubber



ZD-N系列



ZD-N183

.材质/Material: Iron(铁)  
.表面处理/Finish: 黑配金 Black and Golden  
.总高度/ Total Height: 200mm  
.底胶/Bottom rubber : 白胶 white rubber



ZD-N184

.材质/Material: Iron(铁)  
.表面处理/Finish: 镀铬、金色 chrome plated, gold  
.高度/ Height: 150、170mm  
.顶板尺寸/Size of top plate:125\*40\*3.0mm  
.底胶/Bottom rubber : 白胶 white rubber



ZD-N192-A

.材质/Material: Iron(铁)  
.表面处理/Finish: 镀铬、黑色、金色 chrome plated, black, gold  
.高度/ Height: 100、130、150、180、200 mm  
.底胶/Bottom rubber : 白胶 white rubber

ZD-N系列



ZD-N185

.材质/Material: Iron(铁)  
.表面处理/Finish: 金色 gold  
.高度/ Height: 110mm 厚度/Thickness: 3.0mm  
.底胶/Bottom rubber : 白胶 white rubber



ZD-N188

.材质/Material: Iron(铁)  
.表面处理/Finish: 镀铬、黑色、金色 chrome plated, black, gold  
.高度/ Height: 150、180mm  
.底胶/Bottom rubber : 白胶 white rubber



ZD-N192-B

.材质/Material: Iron(铁)  
.表面处理/Finish: 镀铬、黑色、金色 chrome plated, black, gold  
.高度/ Height: 100、130、150、180、200mm  
.底胶/Bottom rubber : 白胶 white rubber



ZD-N192-C

.材质/Material: Iron(铁)  
.表面处理/Finish: 镀铬、黑色、金色 chrome plated, black, gold  
.高度/ Height: 100、130、150、180、200 mm  
.底胶/Bottom rubber : 白胶 white rubber



ZD-N190

.材质/Material: Iron(铁)  
.表面处理/Finish: 镀铬、黑色、金色 chrome plated, black, gold  
.高度/ Height: 110mm  
.底胶/Bottom rubber : 白胶 white rubber



ZD-N195

.材质/Material: 铁 iron  
.表面处理/Finish: 哑黑色、镀铬、金色、青古、红古色  
matte black, chrome plated, gold, bronze, copper  
.高度/height: 100、120mm 厚度/Thickness:2.5mm  
.底胶/Bottom rubber : 白胶 white rubber



ZD-N196

.材质/Material: 铁 iron  
.表面处理/Finish: 哑黑色、镀铬、金色、红古色  
matte black, chrome plated, gold, copper  
.高度/height: 100mm 厚度/Thickness:3.0mm  
.底胶/Bottom rubber : 白胶 white rubber

ZD-N系列



ZD-N197

.材质/Material: 铁 iron  
.表面处理/Finish: 哑黑色、镀铬、金色、玫瑰金  
matte black, chrome plated, gold, Rose Gold  
.规格/size: H130\*L180, 130\*320, 130\*600mm  
.底胶/Bottom rubber: 白胶 white rubber



ZD-N198-A

.材质/Material: 铁 iron  
.表面处理/Finish: 哑黑色、镀铬、金色  
Matte black, chrome plated, gold  
.高度/Height: 80, 100, 120, 150, 180mm  
.底胶/Bottom rubber: 黑胶 black rubber



ZD-N系列



ZD-N201-C

.材质/Material: 铁 iron  
.表面处理/Finish: 哑黑色、镀铬、金色、青古、红古色  
matte black, chrome plated, gold, bronze, copper  
.高度/height: 150mm  
.底胶/Bottom rubber: 黑胶 black rubber



ZD-N199

.材质/Material: 铁 iron  
.表面处理/Finish: 哑黑色、镀铬、金色  
matte black, chrome plated, gold  
.高度/height: 130, 150, 180, 200mm  
.底胶/Bottom rubber: 黑胶 black rubber



ZD-N202

.材质/Material: 铁 iron  
.表面处理/Finish: 黑色、镀铬、金色  
black, chrome plated, gold,  
.高度/height: 120, 150, 180mm  
.底胶/Bottom rubber: 黑胶 black rubber



ZD-N202-A(带网珠)

.材质/Material: 铁 iron  
.表面处理/Finish: 黑色、镀铬、金色  
black, chrome plated, gold,  
.高度/height: 120, 150, 180mm  
.底胶/Bottom rubber: 黑胶 black rubber



ZD-N200

.材质/Material: 铁 iron  
.表面处理/Finish: 哑黑色、镀铬、金色  
matte black, chrome plated, gold  
.高度/height: 160, 180mm  
.底胶/Bottom rubber: 黑胶 black rubber



ZD-N201-B

.材质/Material: 铁 iron  
.表面处理/Finish: 哑黑色、镀铬、金色、青古、红古色  
matte black, chrome plated, gold, bronze, copper  
.高度/height: 150mm



ZD-N202-B

.材质/Material: 铁 iron  
.表面处理/Finish: 黑色、镀铬、金色  
black, chrome plated, gold,  
.高度/height: 200, 250, 350, 450, 500, 600, 750mm  
.底胶/Bottom rubber: 黑胶 black rubber





ZD-N系列



ZD-N202-C

.材质/Material: 铁 iron  
.表面处理/Finish: 黑色、镀铬、金色 black, chrome plated, gold,  
.高度/height: 150, 180, 200mm  
.底胶/Bottom rubber: 黑胶 black rubber



ZD-N202-D

.材质/Material: 铁 iron  
.表面处理/Finish: 黑色、镀铬、金色 black, chrome plated, gold,  
.高度/height: 150, 180, 200mm  
.底胶/Bottom rubber: 黑胶 black rubber



ZD-N204

.材质/Material: 铁 iron  
.表面处理/Finish: 黑色、镀铬、金色 black, chrome plated, gold,  
.高度/height: 150, 180mm  
.底胶/Bottom rubber: 白胶 white rubber

ZD-N系列



ZD-N202-E

.材质/Material: 铁 iron  
.表面处理/Finish: 黑色、镀铬、金色 black, chrome plated, gold,  
.高度/height: 150, 180, 200mm  
.底胶/Bottom rubber: 黑胶 black rubber



ZD-N202-F

.材质/Material: 铁 iron  
.表面处理/Finish: 黑色、镀铬、金色 black, chrome plated, gold,  
.高度/height: 120, 150, 180mm  
.底胶/Bottom rubber: 黑胶 black rubber



ZD-N204-A

.材质/Material: 铁 iron  
.表面处理/Finish: 黑色、镀铬、金色 black, chrome plated, gold,  
.高度/height: 150, 180mm  
.底胶/Bottom rubber: 白胶 white rubber



ZD-N205

.材质/Material: 铁+不锈钢 iron+Stainless steel  
.表面处理/Finish: 金色、玫瑰金 gold, rose gold  
.规格/size: H150\*L940mm  
.底胶/Bottom rubber: 黑胶 black rubber



ZD-N203-B

.材质/Material: 铁 iron  
.表面处理/Finish: 黑色、镀铬、金色 black, chrome plated, gold,  
.高度/height: 170mm 厚度/Thickness: 8.0mm  
.底胶/Bottom rubber: 黑胶 black rubber



ZD-N206

.材质/Material: 铁 iron  
.表面处理/Finish: 黑色、镀铬、金色 black, chrome plated, gold,  
.高度/height: 180mm  
.底胶/Bottom rubber: 黑胶 black rubber



ZD-N207-A/B

.材质/Material: 铁 iron  
.表面处理/Finish: 黑色、镀铬、金色 black, chrome plated, gold  
.规格/size: H80\*T0.5, H100\*T0.5, H140\*T0.5, H160\*T0.5, H200\*T0.5mm  
.底胶/Bottom rubber: 黑胶 black rubber



ZD-N系列



ZD-N208

.材质/Material: 铁 iron  
.表面处理/Finish: 哑黑、镀铬、金色 Matte black, chrome plated, gold  
.高度/height: 180mm  
.底胶/Bottom rubber: 黑胶 black rubber



ZD-N208-A

.材质/Material: 铁 iron  
.表面处理/Finish: 哑黑、镀铬、金色 Matte black, chrome plated, gold  
.高度/height: 200, 240mm  
.底胶/Bottom rubber: 黑胶 black rubber



ZD-N209-B1(空心款)

.材质/Material: 铁 iron  
.表面处理/Finish: 黑色、镀铬、金色 black, chrome plated, gold  
.高度/height: 80, 100, 120, 150 mm  
.厚度/thickness: 1.5 mm  
.底胶/Bottom rubber: 黑胶 black rubber



ZD-N210

.材质/Material: 铁 iron  
.表面处理/Finish: 哑黑、镀铬、金色 Matte black, chrome plated, gold  
.高度/height: 130, 150, 180mm  
.厚度/thickness: 2.0mm  
.底胶/Bottom rubber: 黑胶 black rubber



ZD-N208-B

.材质/Material: 铁 iron  
.表面处理/Finish: 哑黑、镀铬、金色 Matte black, chrome plated, gold  
.高度/height: 130, 150, 180, 200, 240mm  
.底胶/Bottom rubber: 黑胶 black rubber



ZD-N209-A

.材质/Material: 铁 iron  
.表面处理/Finish: 哑黑、镀铬、金色 Matte black, chrome plated, gold  
.高度/height: 150mm  
.底胶/Bottom rubber: 黑胶 black rubber



ZD-N211-B

.材质/Material: 铁 iron  
.表面处理/Finish: 哑黑、镀铬、金色 Matte black, chrome plated, gold  
.高度/height: 100mm 厚度/Thickness: 1.6 mm  
.底胶/Bottom rubber: 白胶 white rubber



ZD-N212-A

.材质/Material: 铁 iron  
.表面处理/Finish: 哑黑、镀铬、金色 Matte black, chrome plated, gold  
.高度/height: 150mm  
.底胶/Bottom rubber: 白胶 white rubber



ZD-N209-B

.材质/Material: 铁 iron  
.表面处理/Finish: 哑黑、镀铬、金色 Matte black, chrome plated, gold  
.高度/height: 80, 100, 120, 150 mm  
.底胶/Bottom rubber: 黑胶 black rubber



ZD-N212-B

.材质/Material: 铁 iron  
.表面处理/Finish: 哑黑、镀铬、金色、枪黑配金 matte black, chrome plated, gold, Gun Black with gold  
.高度/height: 140mm  
.底胶/Bottom rubber: 黑胶 black rubber



ZD-N213

.材质/Material: 铁 iron  
.表面处理/Finish: 哑黑、镀铬、金色 Matte black, chrome plated, gold  
.规格/size: H190\*T8mm  
.底胶/Bottom rubber: 黑胶 black rubber

ZD-N系列



ZD-N214

.材质/Material: 铁 iron  
.表面处理/Finish: 哑黑、镀铬、金色 Matte black, chrome plated, gold  
.规格/size: H170\*T8mm  
.底胶/Bottom rubber: 黑胶 black rubber



ZD-N218

.材质/Material: 铁 iron  
.表面处理/Finish: 哑黑、镀铬、金色、matte black, chrome plated, gold  
.高度/height: 250mm 厚度/Thickness: 6mm  
.底胶/Bottom rubber: 白胶 white rubber

ZD-N系列



ZD-N219-A

.材质/Material: 铁 iron  
.表面处理/Finish: 哑黑、镀铬、金色 Matte black, chrome plated, gold  
.高度/height: 150, 180mm  
.底胶/Bottom rubber: 黑胶 black rubber



ZD-N215-A

.材质/Material: 铁 iron  
.表面处理/Finish: 哑黑、镀铬、金色 Matte black, chrome plated, gold  
.规格/size: H120\*T10, H150\*T10mm  
.底胶/Bottom rubber: 白胶 white rubber



ZD-N215-B

.材质/Material: 铁 iron  
.表面处理/Finish: 哑黑、镀铬、金色 Matte black, chrome plated, gold  
.规格/size: H100\*T10, H120\*T10, H150\*T10mm  
.底胶/Bottom rubber: 白胶 white rubber



ZD-N219-B

.材质/Material: 铁 iron  
.表面处理/Finish: 哑黑、镀铬、金色 Matte black, chrome plated, gold  
.高度/height: 150, 180 mm  
.底胶/Bottom rubber: 黑胶 black rubber



ZD-N220-B

.材质/Material: 铁 iron  
.表面处理/Finish: 哑黑、镀铬、金色 Matte black, chrome plated, gold  
.高度/height: 190, 250mm  
.底胶/Bottom rubber: 白胶 white rubber



ZD-N216

.材质/Material: 铁 iron  
.表面处理/Finish: 哑黑、镀铬、金色 Matte black, chrome plated, gold  
.规格/size: H150\*T10, H180\*T10mm  
.底胶/Bottom rubber: 白胶 white rubber



ZD-N217

.材质/Material: 铁 iron  
.表面处理/Finish: 哑黑、镀铬、金色、matte black, chrome plated, gold  
.规格/size: H150\*T10, H180\*T10, H200\*T10 mm  
.底胶/Bottom rubber: 黑胶 black rubber



ZD-N221

.材质/Material: 铁 iron  
.表面处理/Finish: 哑黑、镀铬、金色 Matte black, chrome plated, gold  
.高度/height: 150, 180, 200mm  
.底胶/Bottom rubber: 黑胶 black rubber



ZD-N222

.材质/Material: 铁 iron  
.表面处理/Finish: 哑黑、镀铬、金色、黑配金 Matte black, chrome plated, gold, black and golden  
.高度/height: 130, 150, 180mm  
.底胶/Bottom rubber: 黑胶 black rubber



ZD-N系列



ZD-N223

.材质/Material: 铁 iron  
.表面处理/Finish: 镀铬、金色、黑色 chrome plated, gold, Black  
.球直径/Ball diameter: 60, 80, 100, 120mm  
.高度/height: 55, 65, 90, 110mm  
.底胶/Bottom rubber: 白胶 white rubber



ZD-N228

.材质/Material: 铁 iron  
.表面处理/Finish: 黑色、镀铬、金色 black, chrome plated, gold,  
.高度/height: 125mm  
.底胶/Bottom rubber: 白胶 white rubber

ZD-N系列



ZD-N229

.材质/Material: 铁 iron  
.表面处理/Finish: 黑色、镀铬、金色 black, chrome plated, gold,  
.高度/height: 125, 165mm  
.底胶/Bottom rubber: 黑胶 black rubber



ZD-N224

.材质/Material: 铁 iron  
.表面处理/Finish: 哑黑、镀铬、金色、青铜色  
Matte black, chrome plated, gold, bronze  
.高度/height: 130mm  
.厚度/thickness: 3.0mm  
.底胶/Bottom rubber: 黑胶 black rubber



ZD-N225

.材质/Material: 铁 iron  
.表面处理/Finish: 哑黑、镀铬、金色  
Matte black, chrome plated, gold,  
.高度/height: 120, 150mm  
.厚度/thickness: 2.0mm  
.底胶/Bottom rubber: 黑胶 black rubber



ZD-N230

.材质/Material: 铁 iron  
.表面处理/Finish: 黑色、镀铬、金色 black, chrome plated, gold,  
.高度/height: 150, 170mm  
.底胶/Bottom rubber: 黑胶 black rubber



ZD-N231

.材质/Material: 铁 iron  
.表面处理/Finish: 黑色、镀铬、金色 black, chrome plated, gold,  
.高度/height: 150mm  
.底胶/Bottom rubber: 黑胶 black rubber



ZD-N226

.材质/Material: 铁 iron  
.表面处理/Finish: 哑黑、镀铬、金色  
Matte black, chrome plated, gold,  
.高度/height: 150, 180mm  
.底胶/Bottom rubber: 黑胶 black rubber



ZD-N227

.材质/Material: 铁 iron  
.表面处理/Finish: 哑黑、镀铬、金色  
Matte black, chrome plated, gold,  
.高度/height: 150, 200mm  
.底胶/Bottom rubber: 黑胶 black rubber



ZD-N233

.材质/Material: 铁 iron  
.表面处理/Finish: 黑色、镀铬、金色 black, chrome plated, gold,  
.高度/height: 160mm  
.底胶/Bottom rubber: 黑胶 black rubber



ZD-N234

.材质/Material: 铁 iron  
.表面处理/Finish: 黑色、镀铬、金色 black, chrome plated, gold,  
.高度/height: 170mm  
.厚度/thickness: 8.0mm  
.底胶/Bottom rubber: 黑胶 black rubber

ZD-N系列



ZD-N235

.材质/Material: 铁 iron  
.表面处理/Finish: 黑色、镀铬、金色 black, chrome plated, gold,  
.高度/height: 120mm  
.底胶/Bottom rubber: 黑胶 black rubber



ZD-N236

.材质/Material: 铁 iron  
.表面处理/Finish: 黑色、金色 black, gold,  
.高度/height: 150、180、200、250 mm  
.底胶/Bottom rubber: 黑胶 black rubber



ZD-N241

.材质/Material: 铁 iron  
.表面处理/Finish: 黑色、镀铬、金色 black, chrome plated, gold,  
.高度/height: 180mm  
.底胶/Bottom rubber: 黑胶 black rubber

ZD-N系列



ZD-N242-A

.材质/Material: 铁 iron  
.表面处理/Finish: 黑色、镀铬、金色 black, chrome plated, gold,  
.高度/height: 100、150mm  
.厚度/thickness: 1.5mm  
.底胶/Bottom rubber: 黑胶 black rubber



ZD-N237

.材质/Material: 铁 iron  
.表面处理/Finish: 黑色、镀铬、金色 black, chrome plated, gold,  
.高度/height: 110mm  
.底胶/Bottom rubber: 黑胶 black rubber



ZD-N238

.材质/Material: 铁 iron  
.表面处理/Finish: 黑色、镀铬、金色 black, chrome plated, gold,  
.高度/height: 180mm  
.底胶/Bottom rubber: 黑胶 black rubber



ZD-N242-B

.材质/Material: 铁 iron  
.表面处理/Finish: 黑色、镀铬、金色 black, chrome plated, gold,  
.高度/height: 120mm 厚度/thickness: 1.5mm  
.底胶/Bottom rubber: 黑胶 black rubber



ZD-N239

.材质/Material: 铁 iron  
.表面处理/Finish: 黑色、镀铬、金色 black, chrome plated, gold,  
.高度/height: 150、180mm  
.底胶/Bottom rubber: 黑胶 black rubber



ZD-N240

.材质/Material: 铁 iron  
.表面处理/Finish: 黑色、镀铬、金色 black, chrome plated, gold,  
.高度/height: 120mm  
.底胶/Bottom rubber: 黑胶 black rubber



ZD-N243

.材质/Material: 铁 iron  
.表面处理/Finish: 黑色、镀铬、金色 black, chrome plated, gold,  
.高度/height: 120mm 厚度/thickness: 2.0mm  
.底胶/Bottom rubber: 白胶 white rubber



ZD-N244-A

.材质/Material: 铁 iron  
.表面处理/Finish: 黑色、镀铬、金色 black, chrome plated, gold,  
.高度/height: 160、180、200mm  
.底胶/Bottom rubber: 白胶 white rubber



ZD-N系列



ZD-N244-B

.材质/Material: 铁 iron  
.表面处理/Finish: 黑色、镀铬、金色 black, chrome plated, gold,  
.高度/height: 150mm  
.底胶/Bottom rubber: 白胶 white rubber



ZD-N245

.材质/Material: 铁 iron  
.表面处理/Finish: 黑色、镀铬、金色 black, chrome plated, gold,  
.高度/height: 140mm 厚度/thickness: 2.0mm  
.底胶/Bottom rubber: 白胶 white rubber



ZD-N249

.材质/Material: 铁 iron  
.表面处理/Finish: 黑色、镀铬、金色 black, chrome plated, gold,  
.高度/height: 190mm  
.底胶/Bottom rubber: 白胶 white rubber



ZD-N250

.材质/Material: 铁 iron  
.表面处理/Finish: 黑色、镀铬、金色 black, chrome plated, gold,  
.高度/height: 120mm  
.底胶/Bottom rubber: 白胶 white rubber



ZD-N245-B

.材质/Material: 铁 iron  
.表面处理/Finish: 黑色、镀铬、金色 black, chrome plated, gold,  
.高度/height: 110, 140mm  
.厚度/thickness: 2.0mm  
.底胶/Bottom rubber: 白胶 white rubber



ZD-N246

.材质/Material: 铁 iron  
.表面处理/Finish: 黑色、镀铬、金色 black, chrome plated, gold,  
.高度/height: 150, 180mm  
.底胶/Bottom rubber: 白胶 white rubber



ZD-N251

.材质/Material: 铁 iron  
.表面处理/Finish: 黑色、镀铬、金色 black, chrome plated, gold,  
.高度/height: 120mm  
.底胶/Bottom rubber: 白胶 white rubber



ZD-N247

.材质/Material: 铁 iron  
.表面处理/Finish: 黑色、镀铬、金色 black, chrome plated, gold,  
.高度/height: 130mm



ZD-N248

.材质/Material: 铁 iron  
.表面处理/Finish: 黑色、镀铬、金色 black, chrome plated, gold,  
.高度/height: 150mm



ZD-N252

.材质/Material: 铁 iron  
.表面处理/Finish: 黑色、镀铬、金色 black, chrome plated, gold,  
.高度/height: 150mm  
.底胶/Bottom rubber: 白胶 white rubber



ZD-N253

.材质/Material: 铁 iron  
.表面处理/Finish: 黑色、镀铬、金色 black, chrome plated, gold,  
.高度/height: 150, 180mm  
.底胶/Bottom rubber: 白胶 white rubber

## ZD-N系列



ZD-N254

.材质/Material: 铁 iron  
.表面处理/Finish: 黑色、镀铬、金色 black、chrome plated、gold、  
.高度/height: 150、180mm  
.底胶/Bottom rubber : 白胶 white rubber



ZD-N255

.材质/Material: 铁 iron  
.表面处理/Finish: 黑色、镀铬、金色 black、chrome plated、gold、  
.高度/height: 160mm 厚度/thickness : 1.8mm  
.底胶/Bottom rubber : 白胶 white rubber



ZD-N259-C (圆管)

.材质/Material: 铁 iron  
.表面处理/Finish: 黑色、镀铬、金色、枪黑配金 black、chrome plated、gold、Gun Black with gold  
.高度/height: 150、180、200、350、450、550mm  
.底胶/Bottom rubber : 黑胶 black rubber

## ZD-N系列



ZD-N260

.材质/Material: 铁 iron  
.表面处理/Finish: 黑色、镀铬、金色、black、chrome plated、gold、  
.高度/height: 170、190mm  
.底胶/Bottom rubber : 黑胶 black rubber



ZD-N256

.材质/Material: 铁 iron  
.表面处理/Finish: 黑色、镀铬、金色、黑配金 black、chrome plated、gold、black and golden  
.高度/height: 150mm  
.底胶/Bottom rubber : 黑胶 black rubber



ZD-N257

.材质/Material: 铁 iron  
.表面处理/Finish: 黑色、镀铬、金色、black、chrome plated、gold、  
.高度/height: 120mm  
.底胶/Bottom rubber : 白胶 white rubber



ZD-N261

.材质/Material: 铁 iron  
.表面处理/Finish: 黑色、镀铬、金色、black、chrome plated、gold、  
.高度/height: 100、120、150mm  
.底胶/Bottom rubber : 黑胶 black rubber



ZD-N262

.材质/Material: 铁 iron  
.表面处理/Finish: 黑色、镀铬、金色、black、chrome plated、gold、  
.高度/height: 150、180mm  
.底胶/Bottom rubber : 黑胶 black rubber



ZD-N258

.材质/Material: 铁 iron  
.表面处理/Finish: 黑色、镀铬、金色、black、chrome plated、gold、  
.高度/height: 190mm  
.底胶/Bottom rubber : 白胶 whiterubber



ZD-N259-B(圆管)

.材质/Material: 铁 iron  
.表面处理/Finish: 黑色、镀铬、金色、枪黑配金 black、chrome plated、gold、Gun Black with gold  
.高度/height: 150、180、200、350、450、550mm  
.底胶/Bottom rubber : 黑胶 black rubber



ZD-N265-A

.材质/Material: 铁 iron  
.表面处理/Finish: 黑色、镀铬、金色、black、chrome plated、gold、  
.高度/height: 160、180mm  
.底胶/Bottom rubber : 黑胶 black rubber



ZD-N265-B

.材质/Material: 铁 iron  
.表面处理/Finish: 黑色、镀铬、金色、black、chrome plated、gold、  
.高度/height: 150、180、210mm  
.底胶/Bottom rubber : 黑胶 black rubber



ZD-N系列



ZD-N265-C

.材质/Material: 铁 iron  
.表面处理/Finish: 黑色、镀铬、金色、black、chrome plated、gold、  
.高度/height: 150、180mm  
.底胶/Bottom rubber : 白胶 white rubber



ZD-N266

.材质/Material: 铁 iron  
.表面处理/Finish: 黑色、镀铬、金色、black、chrome plated、gold、  
.高度/height: 150、180mm  
.底胶/Bottom rubber : 白胶 white rubber



ZD-N271

.材质/Material: 铁 iron  
.表面处理/Finish: 黑色、镀铬、金色、black、chrome plated、gold、  
.高度/height: 150、180、210mm  
.底胶/Bottom rubber : 白胶 white rubber

ZD-N系列



ZD-N272

.材质/Material: 铁 iron  
.表面处理/Finish: 黑色、镀铬、金色、black、chrome plated、gold、  
.高度/height: 120、150、180mm  
.底胶/Bottom rubber : 黑胶 black rubber



ZD-N267

.材质/Material: 铁 iron  
.表面处理/Finish: 黑色、镀铬、金色、black、chrome plated、gold、  
.高度/height: 150、180mm  
.底胶/Bottom rubber : 黑胶 black rubber



ZD-N268

.材质/Material: 铁 iron  
.表面处理/Finish: 黑色、金色、black、gold  
.高度/height: 150、180、200、250mm  
.底胶/Bottom rubber : 黑胶 black rubber



ZD-N273

.材质/Material: 铁 iron  
.表面处理/Finish: 黑色、镀铬、金色、black、chrome plated、gold、  
.高度/height: 160、190mm  
.底胶/Bottom rubber : 白胶 white rubber



ZD-N274

.材质/Material: 铁 iron  
.表面处理/Finish: 黑色、镀铬、金色、black、chrome plated、gold、  
.高度/height: 180mm



ZD-N269

.材质/Material: 铁 iron  
.表面处理/Finish: 黑色、金色、black、gold  
.高度/height: 150、180mm  
.底胶/Bottom rubber : 白胶 white rubber



ZD-N270

.材质/Material: 铁 iron  
.表面处理/Finish: 黑色、镀铬、金色、black、chrome plated、gold、  
.高度/height: 90mm  
.底胶/Bottom rubber : 白胶 white rubber



ZD-N275

.材质/Material: 铁 iron  
.表面处理/Finish: 黑色、镀铬、金色、black、chrome plated、gold、  
.高度/height: 150、180mm  
.底胶/Bottom rubber : 白胶 white rubber



ZD-N系列



ZD-N276

.材质/Material: 铁 iron  
.表面处理/Finish: 黑色、镀铬、金色、black、chrome plated、gold、  
.高度/height: 180mm  
.底胶/Bottom rubber: 黑胶 black rubber



ZD-N277

.材质/Material: 铁 iron  
.表面处理/Finish: 黑色、镀铬、金色、black、chrome plated、gold、  
.规格/size: H100\*T4 mm  
.底胶/Bottom rubber: 黑胶 black rubber



ZD-N280-B

.材质/Material: 铁 iron  
.表面处理/Finish: 黑色、镀铬、金色、black、chrome plated、gold、  
.高度/height: 100, 120, 150 mm  
.底胶/Bottom rubber: 白胶 white rubber



ZD-N281

.材质/Material: 铁 iron  
.表面处理/Finish: 黑色、镀铬、金色、black、chrome plated、gold、  
.高度/height: 150, 170mm  
.底胶/Bottom rubber: 白胶 white rubber



ZD-N278

.材质/Material: 铁 iron  
.表面处理/Finish: 黑色、镀铬、金色、black、chrome plated、gold、  
.规格/size: H100\*T 8.0mm  
.底胶/Bottom rubber: 黑胶 black rubber



ZD-N279

.材质/Material: 铁 iron  
.表面处理/Finish: 黑色、镀铬、金色、black、chrome plated、gold、  
.高度/height: 180mm  
.底胶/Bottom rubber: 黑胶 black rubber



ZD-N282

.材质/Material: 铁 iron  
.表面处理/Finish: 黑色、镀铬、金色、black、chrome plated、gold、  
.高度/height: 150, 180mm  
.底胶/Bottom rubber: 黑胶 black rubber



ZD-N283

.材质/Material: 铁 iron  
.表面处理/Finish: 黑色、镀铬、金色、black、chrome plated、gold、  
.规格/size: H150\*T6.0, H175\*T6.0mm  
.底胶/Bottom rubber: 黑胶 black rubber



ZD-N280

.材质/Material: 铁 iron  
.表面处理/Finish: 黑色、镀铬、金色、black、chrome plated、gold、  
.高度/height: 80, 100, 120, 150 mm  
.底胶/Bottom rubber: 白胶 white rubber



ZD-N284-A(夹心)



.材质/Material: 铁 iron  
.表面处理/Finish: 黑色、镀铬、金色、black、chrome plated、gold、  
.高度/height: 150, 180mm  
.底胶/Bottom rubber: 黑胶 black rubber



ZD-N285

.材质/Material: 铁 iron  
.表面处理/Finish: 黑色、镀铬、金色、black、chrome plated、gold、  
.规格/size: H100\*T 8.0mm  
.底胶/Bottom rubber: 黑胶 black rubber



ZD-N系列



ZD-N286

.材质/Material: 铁 iron  
.表面处理/Finish: 黑色、镀铬、金色、black、chrome plated, gold、  
.高度/height: 180mm  
.底胶/Bottom rubber : 黑胶 black rubber



ZD-N287

.材质/Material: 铁 iron  
.表面处理/Finish: 黑色、镀铬、金色、black、chrome plated, gold、  
.规格/size: H175\*T3.0mm



ZD-N291

.材质/Material: 铁 iron  
.表面处理/Finish: 黑色、镀铬、金色、black、chrome plated, gold、  
.高度/height: 150, 180mm



ZD-N系列

ZD-N292

.材质/Material: 铁 iron  
.表面处理/Finish: 黑色、镀铬、金色、black、chrome plated, gold、  
.高度/height: 160mm  
.底胶/Bottom rubber : 黑胶 black rubber



ZD-N288

.材质/Material: 铁 iron  
.表面处理/Finish: 枪黑配金 Gun Black with gold  
.高度/height: 150, 180, 205mm



ZD-N289

.材质/Material: 铁 iron  
.表面处理/Finish: 黑色、镀铬、金色、black、chrome plated, gold、  
.高度/height: 130, 150, 180 mm



ZD-N293

.材质/Material: 铁 iron  
.表面处理/Finish: 黑色、镀铬、金色、black、chrome plated, gold、  
.高度/height: 120mm  
.底胶/Bottom rubber : 黑胶 black rubber



ZD-N294-A

.材质/Material: 铁 iron  
.表面处理/Finish: 黑色、镀铬、金色、玫瑰金 black, chrome plated, gold, Rose gold  
.高度/height: 80, 100, 120, 150mm  
.底胶/Bottom rubber : 白胶 white rubber



ZD-N290

.材质/Material: 铁 iron  
.表面处理/Finish: 黑色、镀铬、金色、black、chrome plated, gold、  
.规格/size: H140\*T2.5, H180\*T2.5mm  
.底胶/Bottom rubber : 黑胶 black rubber



ZD-N294-B

.材质/Material: 铁 iron  
.表面处理/Finish: 黑色、镀铬、金色、黑配金 black, chrome plated, gold, Black and gold  
.高度/height: 100, 120, 150, 180mm  
.底胶/Bottom rubber : 黑胶 black rubber



ZD-N295

.材质/Material: 铁 iron  
.表面处理/Finish: 黑色、镀铬、金色、black、chrome plated, gold、  
.高度/height: 150mm  
.底胶/Bottom rubber : 白胶 white rubber

ZD-N系列



ZD-N296

.材质/Material: 铁 iron  
.表面处理/Finish: 黑色、镀铬、黑配金 black, chrome plated, Black and gold  
.高度/height: 180mm  
.底胶/Bottom rubber: 黑胶 black rubber



ZD-N297

.材质/Material: 铁 iron  
.表面处理/Finish: 黑色、镀铬、黑配金、金色、玫瑰金 black, chrome plated, Black and gold, Rose Gold  
.高度/height: 150, 180mm  
.底胶/Bottom rubber: 黑胶 black rubber



ZD-N300-B

.材质/Material: 铁 iron  
.表面处理/Finish: 镀铬、金色 chrome plated, gold  
.高度/height: 120, 150, 180 mm  
.总长度/Total Length: 880mm  
.底胶/Bottom rubber: 黑胶 black rubber



ZD-N301

.材质/Material: 铁 iron  
.表面处理/Finish: 镀铬、金色 chrome plated, gold  
.高度/height: 120mm  
.长度/Length: 180\*180mm  
.底胶/Bottom rubber: 白胶 white rubber



ZD-N298

.材质/Material: 铁 iron  
.表面处理/Finish: 黑色、镀铬、金色、玫瑰金 black, chrome plated, gold, Rose Gold  
.高度/height: 100, 120, 150mm  
.底胶/Bottom rubber: 黑胶 black rubber



ZD-N299

.材质/Material: 铁 iron  
.表面处理/Finish: 黑色、镀铬、金色 black, chrome plated, gold  
.高度/height: 130, 150, 200mm  
.底胶/Bottom rubber: 黑胶 black rubber



ZD-N302

.材质/Material: 铁 iron  
.表面处理/Finish: 金色、哑黑、镀铬 gold, matte black, chrome plated  
.高度/height: 150mm  
.底胶/Bottom rubber: 白胶 white rubber



ZD-N309

.材质/Material: 铁 iron  
.表面处理/Finish: 金色、镀铬、哑黑、黑配金 gold, chrome plated, matte black, Black and gold  
.高度/height: 150, 180mm  
.底胶/Bottom rubber: 白胶 white rubber



ZD-N300-A

.材质/Material: 铁 iron  
.表面处理/Finish: 镀铬、金色 chrome plated, gold  
.高度/height: 120, 150, 180 mm  
.总长度/Total Length: 880mm  
.底胶/Bottom rubber: 黑胶 black rubber



ZD-N309-A

.材质/Material: 铁 iron  
.表面处理/Finish: 金色、镀铬、哑黑、黑配金 gold, chrome plated, matte black, Black and gold  
.高度/height: 150, 180mm  
.底胶/Bottom rubber: 白胶 white rubber



ZD-N310

.材质/Material: 铁 iron  
.表面处理/Finish: 金色 Gold  
.高度/height: 150mm 厚度/Thickness: 4.0mm  
.铁片总长/Total length of iron sheet: 600mm  
.底胶/Bottom rubber: 白胶 white rubber



ZD-N系列



ZD-N311

.材质/Material: 铁 iron  
.表面处理/Finish: 黑色、镀铬、金色、black、chrome plated, gold,  
.高度/height: 150、180mm



ZD-N312

.材质/Material: 铁 iron  
.表面处理/Finish: 黑色、镀铬、金色、黑配金 black, chrome plated, gold, Black and gold  
.高度/height: 140mm  
.厚度/Thickness: 2.0mm



ZD-N316

.材质/Material: 铁 iron  
.表面处理/Finish: 哑黑、枪黑、金色、镀铬 Matte black, Gun Black, gold, chrome plated  
.高度/height: 180mm  
.厚度/Thickness: 6.0mm



ZD-N317

.材质/Material: 铁 iron  
.表面处理/Finish: 黑色、镀铬、金色、black、chrome plated, gold,  
.高度/height: 150、180mm



ZD-N313

.材质/Material: 铁 iron  
.表面处理/Finish: 黑色、镀铬、金色、black、chrome plated, gold,  
.高度/height: 150mm  
.厚度/Thickness: 1.5mm



ZD-N318

.材质/Material: 铁 iron  
.表面处理/Finish: 黑色、镀铬、black、chrome plated  
.高度/height: 180mm



ZD-N319

.材质/Material: 铁 iron  
.表面处理/Finish: 黑配金 Black and gold  
.高度/height: 150mm



ZD-N314

.材质/Material: 铁 iron  
.表面处理/Finish: 黑色、镀铬、金色、black、chrome plated, gold,  
.高度/height: 150mm



ZD-N315

.材质/Material: 铁 iron  
.表面处理/Finish: 黑色、镀铬、金色、black、chrome plated, gold,  
.高度/height: 130、150、180mm  
.厚度/Thickness: 2.5mm



ZD-N320-A(不封边)

.材质/Material: 铁 iron  
.表面处理/Finish: 黑色、镀铬、金色、black、chrome plated, gold,  
.高度/height: 180mm  
.厚度/Thickness: 2.0mm



ZD-N320-B(封边)

.材质/Material: 铁 iron  
.表面处理/Finish: 黑色、镀铬、金色、black、chrome plated, gold,  
.高度/height: 180mm  
.厚度/Thickness: 2.0mm

ZD-N系列

ZD-N系列



ZD-N321

.材质/Material: 铁 iron  
.表面处理/Finish: 黑色、镀铬、金色、black、chrome plated, gold、  
.高度/height: 150mm  
.厚度/Thickness: 2.0mm



ZD-N322-A

.材质/Material: 铁 iron  
.表面处理/Finish: 黑色、镀铬、金色、black、chrome plated, gold、  
.高度/height: 150mm



ZD-N323

.材质/Material: 铁 iron  
.表面处理/Finish: 黑色、镀铬、金色、black、chrome plated, gold、  
.高度/height: 150mm



ZD-N322-B

.材质/Material: 铁 iron  
.表面处理/Finish: 黑色、镀铬、金色、black、chrome plated, gold、  
.高度/height: 150mm



ZD-N324-A

.材质/Material: 铁 iron  
.表面处理/Finish: 黑色、镀铬、金色、black、chrome plated, gold、  
.高度/height: 120, 150, 180mm  
.底胶/Bottom rubber: 黑胶 black rubber



ZD-N324-B

.材质/Material: 铁 iron  
.表面处理/Finish: 黑色、镀铬、金色、枪黑配金black、chrome plated, gold, Gun Black and Golden  
.高度/height: 130, 150, 180mm



ZD-N322-C

.材质/Material: 铁 iron  
.表面处理/Finish: 黑色、镀铬、金色、black、chrome plated, gold、  
.高度/height: 150mm



ZD-N322-D

.材质/Material: 铁 iron  
.表面处理/Finish: 黑色、镀铬、金色、black、chrome plated, gold、  
.高度/height: 150mm



ZD-N325

.材质/Material: 铁 iron  
.表面处理/Finish: 黑色、镀铬、金色、black、chrome plated, gold、  
.高度/height: 120, 150mm 厚度/Thickness: 1.5mm  
.底胶/Bottom rubber: 黑胶 black rubber



ZD-N326

.材质/Material: 铁 iron  
.表面处理/Finish: 黑色、镀铬、金色、black、chrome plated, gold、  
.高度/height: 185mm  
.总高度/Total height: 465mm



ZD-N系列



ZD-N329

.材质/Material: 铁 iron  
.表面处理/Finish: 枪黑配金 Gun Black and Golden  
.高度/height: 150, 180, 200mm  
.底胶/Bottom rubber: 黑胶 black rubber



ZD-N330

.材质/Material: 铁 iron  
.表面处理/Finish: 黑色、金色、镀铬 black, gold, chrome plated  
.高度/height: 200mm  
.底胶/Bottom rubber: 白胶 white rubber



ZD-N335

.材质/Material: 铁 iron  
.表面处理/Finish: 黑色、金色、镀铬 black, gold, chrome plated  
.高度/height: 140mm 厚度/Thickness: 2.0mm  
.底胶/Bottom rubber: 黑胶 black rubber

ZD-N系列



ZD-N336

.材质/Material: 铁 iron  
.表面处理/Finish: 黑色、金色、镀铬 black, gold, chrome plated  
.高度/height: 150, 180 mm  
.底胶/Bottom rubber: 黑胶 black rubber



ZD-N331

.材质/Material: 铁 iron  
.表面处理/Finish: 黑色、金色、镀铬 black, gold, chrome plated  
.高度/height: 210mm  
.底胶/Bottom rubber: 白胶 white rubber



ZD-N332

.材质/Material: 铁 iron  
.表面处理/Finish: 黑色、金色、镀铬 black, gold, chrome plated  
.高度/height: 150, 180, 200mm  
.底胶/Bottom rubber: 黑胶 black rubber



ZD-N337

.材质/Material: 铁 iron  
.表面处理/Finish: 黑色、金色、镀铬 black, gold, chrome plated  
.高度/height: 150, 180 mm  
.底胶/Bottom rubber: 白胶 white rubber



ZD-N333

.材质/Material: 铁 iron  
.表面处理/Finish: 黑色、金色、镀铬 black, gold, chrome plated  
.高度/height: 150, 180 mm  
.厚度/Thickness: 2.0mm  
.底胶/Bottom rubber: 黑胶 black rubber



ZD-N334

.材质/Material: 铁 iron  
.表面处理/Finish: 枪黑配金 Gun Black and Golden  
.高度/height: 130, 150, 180, 200mm



ZD-N338

.材质/Material: 铁 iron  
.表面处理/Finish: 黑色、金色、镀铬 black, gold, chrome plated  
.高度/height: 120, 150, 180 mm  
.底胶/Bottom rubber: 白胶 white rubber



ZD-N339

.材质/Material: 铁 iron  
.表面处理/Finish: 黑色、金色、镀铬 black, gold, chrome plated  
.高度/height: 140, 180 mm  
.厚度/Thickness: 2.0mm  
.底胶/Bottom rubber: 黑胶 black rubber

ZD-N系列



ZD-N342

.材质/Material: 铁 iron  
.表面处理/Finish: 黑色、金色、镀铬 black, gold, chrome plated  
.高度/height: 170mm  
.底胶/Bottom rubber: 黑胶 black rubber



ZD-N345

.材质/Material: 铁 iron  
.表面处理/Finish: 黑色 black  
.高度/height: 140mm  
.底胶/Bottom rubber: 黑胶 black rubber

ZD-N系列



ZD-N346

.材质/Material: 铁 iron  
.表面处理/Finish: 黑色、金色、镀铬 black, gold, chrome plated  
.高度/height: 180mm  
.底胶/Bottom rubber: 白胶 white rubber



ZD-N343-A

.材质/Material: 铁 iron  
.表面处理/Finish: 黑色、金色、镀铬 black, gold, chrome plated  
.高度/height: 180 mm  
.底胶/Bottom rubber: 黑胶 black rubber



ZD-N343-B

.材质/Material: 铁 iron  
.表面处理/Finish: 黑色、金色、镀铬 black, gold, chrome plated  
.高度/height: 180 mm  
.底胶/Bottom rubber: 黑胶 black rubber



ZD-N347

.材质/Material: 铁 iron  
.表面处理/Finish: 黑色、镀铬、黑配金 black, gold, chrome plated, Black and gold  
.高度/height: 150, 180 mm  
.底胶/Bottom rubber: 黑胶 black rubber



ZD-N344

.材质/Material: 铁 iron  
.表面处理/Finish: 黑色 black  
.高度/height: 83mm  
.底胶/Bottom rubber: 黑胶 black rubber



ZD-N348

.材质/Material: 铁 iron  
.表面处理/Finish: 黑色、金色、镀铬 black, gold, chrome plated  
.高度/height: 130, 150mm  
.底胶/Bottom rubber: 黑胶 black rubber



ZD-N349

.材质/Material: 铁 iron  
.表面处理/Finish: 黑色、金色、镀铬 black, gold, chrome plated  
.高度/height: 150, 180, 210mm  
.底胶/Bottom rubber: 白胶 white rubber



ZD-N系列



ZD-N350

.材质/Material: 铁 iron  
.表面处理/Finish: 黑色、金色、镀铬 black, gold, chrome plated  
.高度/height: 150mm  
.底胶/Bottom rubber: 白胶 white rubber



ZD-N351-A (直款)

.材质/Material: 铁 iron  
.表面处理/Finish: 黑色、金色、镀铬 black, gold, chrome plated  
.高度/height: 150, 180mm  
.底胶/Bottom rubber: 白胶 white rubber



ZD-N系列



ZD-N355

.材质/Material: 铁 iron  
.表面处理/Finish: 黑色、金色、镀铬 black, gold, chrome plated  
.高度/height: 150 mm



ZD-N351-B(弯款)

.材质/Material: 铁 iron  
.表面处理/Finish: 黑色、金色、镀铬 black, gold, chrome plated  
.高度/height: 150, 180 mm  
.底胶/Bottom rubber: 黑胶 black rubber



ZD-N352-B

.材质/Material: 铁 iron  
.表面处理/Finish: 黑配金、木纹配金 Black and gold, wooden and gold  
.高度/height: 100 mm



ZD-N356-A

.材质/Material: 铁 iron  
.表面处理/Finish: 黑色、金色、镀铬 black, gold, chrome plated  
.高度/height: 150 mm



ZD-N356-C

.材质/Material: 铁 iron  
.表面处理/Finish: 黑色、金色、镀铬 black, gold, chrome plated  
.高度/height: 120 mm



ZD-N353

.材质/Material: 铁 iron  
.表面处理/Finish: 黑色、金色、镀铬、木纹色 black, gold, chrome plated, wooden color  
.高度/height: 150, 180 mm



ZD-N354

.材质/Material: 铁 iron  
.表面处理/Finish: 黑色、金色、镀铬 black, gold, chrome plated  
.高度/height: 50, 60, 80, 100, 120, 150 mm  
.顶板尺寸/Size of Top plate: L60\*W30\*T1.0mm



ZD-N356-D

.材质/Material: 铁 iron  
.表面处理/Finish: 黑色、金色、镀铬 black, gold, chrome plated  
.高度/height: 130 mm



ZD-N358-A

.材质/Material: 铁 iron  
.表面处理/Finish: 黑色、金色、镀铬 black, gold, chrome plated  
.高度/height: 150, 180, 200, 250 mm  
.底胶/Bottom rubber: 黑胶 black rubber

ZD-N系列



ZD-N358-B

.材质/Material: 铁 iron  
.表面处理/Finish: 黑色、金色、镀铬 black, gold, chrome plated  
.高度/height: 150、180、200、250 mm  
.底胶/Bottom rubber : 黑胶 black rubber



ZD-N358-C

.材质/Material: 铁 iron  
.表面处理/Finish: 黑色、金色、镀铬 black, gold, chrome plated  
.高度/height: 150、180 mm  
.底胶/Bottom rubber : 黑胶 black rubber



ZD-N359

.材质/Material: 铁 iron  
.表面处理/Finish: 黑配金 Black and gold  
.高度/height: 150 mm  
.底胶/Bottom rubber : 黑胶 black rubber



ZD-N360

.材质/Material: 铁 iron  
.表面处理/Finish: 黑色、金色、镀铬 black, gold, chrome plated  
.高度/height: 140mm  
.底胶/Bottom rubber : 黑胶 black rubber



ZD-N363

.材质/Material: 铁 iron  
.表面处理/Finish: 黑色、金色、镀铬 black, gold, chrome plated  
.高度/height: 120、150 mm  
.底胶/Bottom rubber : 白胶 white rubber



ZD-N361

.材质/Material: 铁 iron  
.表面处理/Finish: 黑色、金色、镀铬 black, gold, chrome plated  
.高度/height: 180mm  
.底胶/Bottom rubber : 白胶 white rubber



ZD-N362-A

.材质/Material: 铁 iron  
.表面处理/Finish: 黑色、金色、镀铬 black, gold, chrome plated  
.高度/height: 80、100 mm  
.底胶/Bottom rubber : 白胶 white rubber



ZD-N362-B

.材质/Material: 铁 iron  
.表面处理/Finish: 黑色、金色、镀铬 black, gold, chrome plated  
.高度/height: 80、100 mm  
.底胶/Bottom rubber : 白胶 white rubber



ZD-N364-A

.材质/Material: 铁 iron  
.表面处理/Finish: 黑色、金色、镀铬 black, gold, chrome plated  
.高度/height: 150 mm  
.底胶/Bottom rubber : 黑胶 black rubber



ZD-N系列



ZD-N364-C

.材质/Material: 铁 iron  
.表面处理/Finish: 黑色、金色、镀铬 black, gold, chrome plated  
.高度/height: 150 mm  
.底胶/Bottom rubber: 黑胶 black rubber



ZD-N365-A

.材质/Material: 铁 iron  
.表面处理/Finish: 黑色、金色、镀铬 black, gold, chrome plated  
.高度/height: 180 mm  
.底胶/Bottom rubber: 黑胶 black rubber



ZD-N367-B

.材质/Material: 铁 iron  
.表面处理/Finish: 黑色、金色、镀铬 black, gold, chrome plated  
.高度/height: 150mm 厚度/Thickness:8mm  
.底胶/Bottom rubber: 白胶 white rubber



ZD-N367-C

.材质/Material: 铁 iron  
.表面处理/Finish: 黑色、金色、镀铬 black, gold, chrome plated  
.高度/height: 150mm 厚度/Thickness:8mm  
.底胶/Bottom rubber: 白胶 white rubber



ZD-N365-B

.材质/Material: 铁 iron  
.表面处理/Finish: 黑色、金色、镀铬 black, gold, chrome plated  
.高度/height: 180 mm  
.底胶/Bottom rubber: 黑胶 black rubber



ZD-N365-C

.材质/Material: 铁 iron  
.表面处理/Finish: 黑色、金色、镀铬 black, gold, chrome plated  
.高度/height: 180 mm  
.底胶/Bottom rubber: 黑胶 black rubber



ZD-N367-D

.材质/Material: 铁 iron  
.表面处理/Finish: 黑色、金色、镀铬 black, gold, chrome plated  
.高度/height: 150mm 厚度/Thickness:8mm  
.底胶/Bottom rubber: 白胶 white rubber



ZD-N368

.材质/Material: 铁 iron  
.表面处理/Finish: 黑色、金色、镀铬 black, gold, chrome plated  
.高度/height: 120、150、180 mm  
.厚度/Thickness:8mm  
.底胶/Bottom rubber: 黑胶 black rubber



ZD-N366-B

.材质/Material: 铁 iron  
.表面处理/Finish: 黑色、金色、镀铬 black, gold, chrome plated  
.高度/height: 120、150 mm  
.厚度/thickness: 2.5mm  
.底胶/Bottom rubber: 黑胶 black rubber



ZD-N367-A

.材质/Material: 铁 iron  
.表面处理/Finish: 黑色、金色、镀铬 black, gold, chrome plated  
.高度/height: 150mm 厚度/Thickness:8mm  
.底胶/Bottom rubber: 白胶 white rubber



ZD-N369

.材质/Material: 铁 iron  
.表面处理/Finish: 黑色、金色、镀铬 black, gold, chrome plated  
.高度/height: 130、150 mm  
.厚度/Thickness:2.0mm  
.底胶/Bottom rubber: 白胶 white rubber



ZD-N系列



ZD-N370-A

.材质/Material: 铁 iron  
.表面处理/Finish: 黑色、金色、镀铬 black, gold, chrome plated  
.高度/height: 100, 120, 150, 180 mm  
.厚度/Thickness: 2.0mm  
.底胶/Bottom rubber : 白胶 white rubber



ZD-N374-A

.材质/Material: 铁 iron  
.表面处理/Finish: 黑色、金色、镀铬 black, gold, chrome plated  
.高度/height: 165 mm  
.底胶/Bottom rubber : 黑胶 black rubber

ZD-N系列



ZD-N374-B

.材质/Material: 铁 iron  
.表面处理/Finish: 黑色、金色、镀铬 black, gold, chrome plated  
.高度/height: 165 mm  
.底胶/Bottom rubber : 黑胶 black rubber



ZD-N370-B

.材质/Material: 铁 iron  
.表面处理/Finish: 黑色、金色、镀铬 black, gold, chrome plated  
.高度/height: 100, 120, 150, 180 mm  
.厚度/Thickness: 2.0mm  
.底胶/Bottom rubber : 白胶 white rubber



ZD-N371-A

.材质/Material: 铁 iron  
.表面处理/Finish: 黑色、金色、镀铬 black, gold, chrome plated  
.高度/height: 100, 120, 180 mm  
.底胶/Bottom rubber : 白胶 white rubber



ZD-N375

.材质/Material: 铁 iron  
.表面处理/Finish: 黑色、金色、镀铬 black, gold, chrome plated  
.高度/height: 150, 180, 200 mm  
.底胶/Bottom rubber : 黑胶 black rubber



ZD-N376

.材质/Material: 铁 iron  
.表面处理/Finish: 黑色、金色、镀铬 black, gold, chrome plated  
.高度/height: 130, 150, 180 mm  
.厚度/Thickness: 1.5 mm  
.底胶/Bottom rubber : 黑胶 black rubber



ZD-N372-A

.材质/Material: 铁 iron  
.表面处理/Finish: 黑色、金色、镀铬 black, gold, chrome plated  
.高度/height: 100, 120, 180 mm  
.底胶/Bottom rubber : 白胶 white rubber



ZD-N373

.材质/Material: 铁 iron  
.表面处理/Finish: 黑色、金色、镀铬 black, gold, chrome plated  
.高度/height: 220 mm  
.底胶/Bottom rubber : 白胶 white rubber



ZD-N379

.材质/Material: 铁 iron  
.表面处理/Finish: 黑色、金色、镀铬 black, gold, chrome plated  
.高度/height: 130, 150, 180 mm  
.底胶/Bottom rubber : 黑胶 black rubber



ZD-N380

.材质/Material: 铁 iron  
.表面处理/Finish: 黑色、金色、镀铬 black, gold, chrome plated  
.高度/height: 150 mm  
.底胶/Bottom rubber : 白胶 white rubber



ZD-A系列



**ZD-A001** (78底直管脚)

.材质/Material: 铁 Iron  
.表面处理/Finish: 镀铬 chrome plated  
.高度/height: 60, 80, 100, 120, 150mm  
.厚度/Thickness: 0.6mm  
.管径/Tube diameter: 50mm  
.底径/Base diameter: 78mm  
.底座/Base Rubber: 黑胶 black rubber  
.备注/Remark: 尺寸可订做: size can be customized



ZD-A系列

**ZD-A002** (68底直管脚)

.材质/Material: 铁 Iron  
.表面处理/Finish: 镀铬 chrome plated  
.高度/height: 40, 60, 80, 100, 120, 150mm  
.厚度/Thickness: 0.3, 0.6 mm  
.管径/Tube diameter: 45, 50mm  
.底径/Base diameter: 68mm  
.底座/Base Rubber: 黑胶 black rubber  
.备注/Remark: 尺寸可订做: size can be customized



**ZD-A003**

.材质/Material: 铁 Iron  
.表面处理/Finish: 镀铬+抛光 chrome plated+Polishing  
.高度/height: 80, 100, 120, 140, 150mm  
.厚度/Thickness: 1.0mm  
.管径/Tube diameter: 60, 85 mm  
.底径/Base diameter: 80, 100mm  
.底座/Base Rubber: 黑胶 black rubber  
.备注/Remark: 尺寸可订做: size can be customized



**ZD-A015**

.材质/Material: 铁 Iron  
.表面处理/Finish: 镀铬 chrome plated  
.高度/height: 60, 80, 100, 120, 150mm  
.底座/Base Rubber: 黑胶 black rubber



**ZD-A016**

.材质/Material: 铁 Iron  
.表面处理/Finish: 镀铬 chrome plated  
.高度/height: 60, 80, 100mm  
.底座/Base Rubber: 黑胶 black rubber



**ZD-A017** (50圆管可调)

.材质/Material: 铁 / 不锈钢 Iron/Stainless steel  
.表面处理/Finish: 镀铬/拉丝 chrome plated/brushed  
.高度/height: 60, 80, 100, 120, 150mm  
.厚度/Thickness: 0.3, 0.6, 0.9mm  
.管径/Tube diameter: 50, 60mm  
.底座/Base Rubber: 黑胶 black rubber

ZD-B系列



**ZD-A018** (38圆管可调)

.材质/Material: 铁 Iron  
.表面处理/Finish: 镀铬 chrome plated  
.高度/height: 60, 80, 100, 120, 150, 200mm  
.厚度/Thickness: 1.0mm  
.管径/Tube diameter: 38mm  
.底胶/Base Rubber: 黑胶 black rubber



**ZD-A019** (30圆管可调)

.材质/Material: 铁 Iron  
.表面处理/Finish: 镀铬/拉丝 chrome plated/brushed  
.高度/height: 60, 80, 100, 120mm  
.厚度/Thickness: 0.6mm  
.管径/Tube diameter: 30mm  
.底胶/Base Rubber: 黑胶 black rubber



**ZD-B003** (10分酒杯)

.材质/Material: 铁 Iron  
.表面处理/Finish: 镀铬 chrome plated  
.高度/height: 90mm  
.底胶/Base Rubber: 黑胶 black rubber



**ZD-B004** (灯罩100喇叭杯)

.材质/Material: 铁 Iron  
.表面处理/Finish: 镀铬 chrome plated  
.高度/height: 88mm  
.底胶/Base Rubber: 黑胶 black rubber



**ZD-A020** (25方管可调脚)

.材质/Material: 铁 iron  
.表面处理/Finish: 镀铬/拉丝 Chrome plated/Brushend  
.管规格/Tube Size: 25\*25mm  
.高度/Height: 60, 80, 100mm  
.厚度/Thickness: 0.7mm  
.底胶/Base Rubber: 黑胶 black rubber



**ZD-A021**

.材质/Material: 铁 iron  
.表面处理/Finish: 镀铬 Chrome plated  
.高度/Height: 700, 720, 750mm  
.厚度/Thickness: 0.7mm  
.底胶/Base Rubber: 黑胶 black rubber



**ZD-B005** (9分小酒杯)

.材质/Material: 铁 Iron  
.表面处理/Finish: 镀铬 chrome plated  
.高度/height: 83mm  
.底胶/Base Rubber: 黑胶 black rubber



**ZD-B001** (小底花瓶)

.材质/Material: 铁 Iron  
.表面处理/Finish: 镀铬、金色 chrome plated, gold  
.高度/height: 90mm  
.底胶/Base Rubber: 黑胶 black rubber



**ZD-B002** (中底花瓶)

.材质/Material: 铁 Iron  
.表面处理/Finish: 镀铬、金色 chrome plated, gold  
.高度/height: 90mm  
.底胶/Base Rubber: 黑胶 black rubber



**ZD-B006** (6分小酒杯)

.材质/Material: 铁 Iron  
.表面处理/Finish: 镀铬 chrome plated  
.高度/height: 65mm  
.底胶/Base Rubber: 黑胶 black rubber



**ZD-B007** (12分牛眼)

.材质/Material: 铁 Iron  
.表面处理/Finish: 镀铬、金色 chrome plated, gold  
.高度/height: 105 mm  
.底胶/Base Rubber: 透明胶 transparent rubber



ZD-B系列



ZD-B008-A

.材质/Material: 铁 Iron  
.表面处理/Finish: 镀铬 chrome plated  
.高度/height: 70、80、90 mm  
.底胶/Base Rubber: 黑胶 black rubber



ZD-B009 (90条纹脚)

.材质/Material: 铁 Iron  
.表面处理/Finish: 镀铬 chrome plated  
.高度/height: 70、90 mm  
.底胶/Base Rubber: 透明胶 transparent rubber



ZD-B016-B(斜脚)

.材质/Material: 铁 Iron  
.表面处理/Finish: 镀铬 chrome plated  
.高度/height: 120 mm  
.底胶/Base Rubber: 黑胶 black rubber



ZD-B010 (95条纹脚)

.材质/Material: 铁 Iron  
.表面处理/Finish: 镀铬 chrome plated  
.高度/height: 95 mm  
.底胶/Base Rubber: 透明胶 transparent rubber



ZD-B011 (110条纹脚)

.材质/Material: 铁 Iron  
.表面处理/Finish: 镀铬 chrome plated  
.高度/height: 110 mm  
.底胶/Base Rubber: 透明胶 transparent rubber



ZD-C001-B

.材质/Material: 铁 Iron  
.表面处理/Finish: 镀铬 chrome plated  
.高度/height: 130 mm  
.底胶/Base Rubber: 黑胶 black rubber



ZD-B014

.材质/Material: 铁 Iron  
.表面处理/Finish: 镀铬 chrome plated  
.高度/height: 100 mm  
.底胶/Base Rubber: 白胶 white rubber



ZD-B016-A(锥形脚)

.材质/Material: 铁 Iron  
.表面处理/Finish: 镀铬 chrome plated  
.高度/height: 120 mm  
.底胶/Base Rubber: 黑胶 black rubber



ZD-C002

.材质/Material: 铁 Iron  
.表面处理/Finish: 镀铬 chrome plated  
.高度/height: 100、120 mm  
.厚度/Thickness: 1.0 mm  
.底胶/Base Rubber: 黑胶 black rubber



ZD-C001-A(大龙脚)

.材质/Material: 铁 Iron  
.表面处理/Finish: 镀铬 chrome plated  
.高度/height: 130 mm 厚度/Thickness: 1.0 mm  
.底胶/Base Rubber: 黑胶 black rubber



ZD-C003

.材质/Material: 铁 Iron  
.表面处理/Finish: 镀铬 chrome plated  
.高度/height: 100 mm  
.厚度/Thickness: 1.0、1.2 mm  
.底胶/Base Rubber: 黑胶 black rubber

ZD-C系列



ZD-C004

.材质/Material: 铁 Iron  
.表面处理/Finish: 镀铬 chrome plated  
.高度/height: 90、95、100、110mm  
.厚度/Thickness: 1.0、1.2、1.5 mm  
.底胶/Base Rubber: 白胶 white rubber



ZD-C005(中牛脚)

.材质/Material: 铁 Iron  
.表面处理/Finish: 镀铬 chrome plated  
.高度/height: 110、120mm  
.厚度/Thickness: 1.0、1.2、1.5、1.8 mm  
.底胶/Base Rubber: 白胶 white rubber



ZD-C008(香蕉脚)

.材质/Material: 铁 Iron  
.表面处理/Finish: 镀铬 chrome plated  
.高度/height: 110 mm  
.厚度/Thickness: 1.2 mm  
.底胶/Base Rubber: 白胶 white rubber



ZD-C014 (单层杯)

.材质/Material: 铁 Iron  
.表面处理/Finish: 镀铬 chrome plated  
.高度/height: 50 mm  
.底胶/Base Rubber: 黑胶 black rubber



ZD-C015 (地毯脚)

.材质/Material: 铁 Iron  
.表面处理/Finish: 镀铬、金色 Chrome plated, gold  
.高度/height: 45mm  
.底胶/Base Rubber: 黑胶 black rubber

ZD-D系列



ZD-D001-A

.材质/Material: 铁 Iron  
.表面处理/Finish: 镀铬、金色、哑黑 Chrome plated, gold, matte black  
.高度/height: 100、130、150、170mm  
.厚度/Thickness: 1.8、2.5mm  
.底胶/Base Rubber: 白胶 white rubber



ZD-D001-B(大三叉宽边脚)

.材质/Material: 铁 Iron  
.表面处理/Finish: 镀铬、金色、哑黑 Chrome plated, gold, matte black  
.高度/height: 100、130、150、170mm  
.厚度/Thickness: 1.8、2.5mm  
.底胶/Base Rubber: 白胶 white rubber



ZD-D001-D1 (加小管)

.材质/Material: 铁 Iron  
.表面处理/Finish: 镀铬、金色、哑黑 Chrome plated, gold, matte black  
.高度/height: 120、150mm  
.底胶/Base Rubber: 白胶 white rubber



ZD-D001-D2

.材质/Material: 铁 Iron  
.表面处理/Finish: 镀铬、金色、哑黑 Chrome plated, gold, matte black  
.高度/height: 120、150mm  
.底胶/Base Rubber: 白胶 white rubber



ZD-D001-D3

.材质/Material: 铁 Iron  
.表面处理/Finish: 镀铬、金色、哑黑 Chrome plated, gold, matte black  
.高度/height: 120、150mm  
.底胶/Base Rubber: 白胶 white rubber



ZD-D系列



**ZD-D001-E** 叉形三叉脚

.材质/Material: 铁iron  
.表面处理/Finish: 镀铬、哑黑、拉丝 Chrome plated, matte black, Brushed  
.高度/height: 100, 130, 150, 170mm  
.厚度/Thickness: 1.8, 2.5mm  
.底胶/Base Rubber: 白胶 white rubber



**ZD-D001-F**

.材质/Material: 铁iron  
.表面处理/Finish: 镀铬、黑色、金色 Chrome plated, black, gold  
.高度/height: 130mm  
.厚度/Thickness: 2.5mm  
.底胶/Base Rubber: 白胶 white rubber



**ZD-D002 (工字脚)**

.材质/Material: 铁iron  
.表面处理/Finish: 镀铬 Chrome plated  
.高度/height: 80/100mm  
.厚度/Thickness: 4.8mm  
.底胶/Base Rubber: 白胶 white rubber



**ZD-D001-E1**

.材质/Material: 铁iron  
.表面处理/Finish: 金色、镀铬、黑色 gold Chrome plated, black  
.高度/height: 100, 130, 150, 170mm  
.厚度/Thickness: 2.5mm  
.底胶/Base Rubber: 白胶 white rubber



**ZD-D001-E2**

.材质/Material: 铁iron  
.表面处理/Finish: 镀铬、黑色、金色 Chrome plated, black, gold  
.高度/height: 130, 150mm  
.厚度/Thickness: 2.5mm  
.底胶/Base Rubber: 白胶 white rubber



**ZD-D002-A**

.材质/Material: 铁iron  
.表面处理/Finish: 镀铬 Chrome plated  
.高度/height: 60/80/100mm  
.厚度/Thickness: 1.0 mm  
.底胶/Base Rubber: 白胶 white rubber



**ZD-D001-E3**

.材质/Material: 铁iron  
.表面处理/Finish: 镀铬、黑色、金色 Chrome plated, black, gold  
.高度/height: 100, 130, 150, 170mm  
.厚度/Thickness: 2.0mm  
.底胶/Base Rubber: 白胶 white rubber



**ZD-D002-B**

.材质/Material: 铁iron  
.表面处理/Finish: 镀铬 Chrome plated  
.高度/height: 60/80/100mm  
.厚度/Thickness: 1.0 mm  
.底胶/Base Rubber: 白胶 white rubber



**ZD-D003-A (6分二合一)**

.材质/Material: 铁iron  
.表面处理/Finish: 黑色、镀铬、金色、玫瑰金、青古、红古 Black Chrome plated, Gold, Rose gold, Bronze, Copper  
.高度/height: 55mm  
.厚度/Thickness: 1.0, 1.2 mm  
.底胶/Base Rubber: 白胶 white rubber

ZD-D系列



**ZD-D003-B**(6分二合一)

.材质/Material: 铁iron  
.表面处理/Finish: 黑色、镀铬、金色、玫瑰金、青古、红古 Black Chrome plated, Gold, Rose gold, Bronze, Copper  
.高度/height: 55mm  
.厚度/Thickness: 1.0、1.2 mm  
.底胶/Base Rubber: 白胶 white rubber



**ZD-D003-C**

.材质/Material: 铁iron  
.表面处理/Finish: 黑色、镀铬、金色、玫瑰金、青古、红古 Black Chrome plated, Gold, Rose gold, Bronze, Copper  
.高度/height: 30mm  
.厚度/Thickness: 1.0 mm  
.底胶/Base Rubber: 白胶 white rubber



**ZD-D004-A**

.材质/Material: 铁iron  
.表面处理/Finish: 黑色、镀铬、金色、玫瑰金、青古、红古 Black Chrome plated, Gold, Rose gold, Bronze, Copper  
.高度/height: 55mm  
.厚度/Thickness: 1.0、1.2 mm  
.底胶/Base Rubber: 白胶 white rubber



**ZD-D006**(分二合一)

.材质/Material: 铁 Iron  
.表面处理/Finish: 黑色、镀铬、金色、玫瑰金 Black Chrome plated, Gold, Rose gold  
.高度/height: 55mm  
.厚度/Thickness: 1.2、1.5 mm  
.底胶/Base Rubber: 白胶 white rubber



**ZD-D007** (7字脚)

.材质/Material: 铁iron  
.表面处理/Finish: 镀铬 Chrome plated  
.高度/height: 55mm  
.厚度/Thickness: 1.2 mm  
.底胶/Base Rubber: 白胶 white rubber



**ZD-D004-B**(6分花紋二合一)

.材质/Material: 铁iron  
.表面处理/Finish: 黑色、镀铬、金色、玫瑰金、青古、红古 Black Chrome plated, Gold, Rose gold, Bronze, Copper  
.高度/height: 55mm  
.厚度/Thickness: 1.0、1.2 mm  
.底胶/Base Rubber: 白胶 white rubber



**ZD-D005-A**(8分二合一)

.材质/Material: 铁 Iron  
.表面处理/Finish: 镀铬 Chrome plated  
.高度/height: 83mm  
.厚度/Thickness: 1.2 mm  
.底胶/Base Rubber: 白胶 white rubber



**ZD-D008**(8分二合一)

.材质/Material: 铁 iron  
.表面处理/Finish: 黑色、镀铬、金色、白色、青古、红古 black, chrome plated, gold, white, bronze, copper  
.高度/height: 80、100 mm  
.厚度/Thickness: 1.0、1.2mm  
.底胶/Base rubber: 白胶 white rubber



**ZD-D009-A**

.材质/Material: 铁 iron  
.表面处理/Finish: 黑色、镀铬、金色、白色、青古、红古 black, chrome plated, gold, white, bronze, copper  
.高度/height: 80 mm  
.厚度/Thickness: 1.0、1.2mm  
.底胶/Base rubber: 白胶 white rubber



ZD-D系列



**ZD-D005-B**(8分二合一)

.材质/Material: 铁iron  
.表面处理/Finish: 抛光 Polish  
.高度/height: 83mm  
.厚度/Thickness: 1.2 mm  
.底胶/Base Rubber: 白胶 white rubber



ZD-D系列



ZD-D009-B

.材质/Material: 铁 iron  
.表面处理/Finish: 黑色、镀铬、金色、白色、青古、红古  
black, chrome plated, gold, white, bronze, copper  
.高度/height: 100 mm  
.厚度/Thickness: 1.0、1.2mm  
.底座/Base rubber : 白胶 white rubber



ZD-D019

.材质/Material: 铁 iron  
.表面处理/Finish: 黑色、镀铬、金色、白色、青古、红古  
black, chrome plated, gold, white, bronze, copper  
.高度/height: 80、100mm  
.厚度/Thickness: 1.2mm  
.底座/Base rubber : 白胶 white rubber

ZD-D系列



ZD-D020-A

.材质/Material: 铁 iron  
.表面处理/Finish: 金色 gold  
.高度/Height: 130mm  
.厚度/thickness: 1.8mm  
.底座/Bottom rubber : 白胶 white rubber



ZD-D013

.材质/Material: 铁 iron  
.表面处理/Finish: 黑色、镀铬、金色、白色、青古、红古  
black, chrome plated, gold, white, bronze, copper  
.高度/height: 100、120mm  
.厚度/Thickness: 1.2、1.5mm  
.底座/Base rubber : 白胶 white rubber



ZD-D015

.材质/Material: 铁 iron  
.表面处理/Finish: 黑色、镀铬、金色、白色、青古、红古  
black, Chrome plated, gold, white, bronze, copper  
.高度/height: 80mm  
.底座/Base rubber : 白胶 white rubber



ZD-D020-B

.材质/Material: 铁 iron  
.表面处理/Finish: 金色 gold  
.高度/Height: 130mm  
.厚度/thickness: 1.8mm  
.底座/Bottom rubber : 白胶 white rubber



ZD-D020-C

.材质/Material: 铁 iron  
.表面处理/Finish: 金色 gold  
.高度/Height: 130mm  
.厚度/thickness: 1.8mm  
.底座/Bottom rubber : 白胶 white rubber



ZD-D016

.材质/Material: 铁 iron  
.表面处理/Finish: 黑色、镀铬、金色、白色、青古、红古  
black, chrome plated, gold, white, bronze, copper  
.高度/height: 120、150mm  
.厚度/Thickness: 1.5、1.8mm  
.底座/Base rubber : 白胶 white rubber



ZD-D018

.材质/Material: 铁 iron  
.表面处理/Finish: 黑色、镀铬、金色、白色、青古、红古  
black, chrome plated, gold, white, bronze, copper  
.高度/height: 80、100mm  
.厚度/Thickness: 1.2mm  
.底座/Base rubber : 白胶 white rubber



ZD-D020-D

.材质/Material: 铁 iron  
.表面处理/Finish: 金色 gold  
.高度/Height: 130mm  
.厚度/thickness: 1.8mm  
.底座/Bottom rubber : 白胶 white rubber



ZD-D系列



ZD-D020-E

.材质/Material: 铁 iron  
.表面处理/Finish: 金色 gold  
.高度/Height: 130mm  
.厚度/thickness: 1.8mm  
.底胶/Bottom rubber: 白胶 white rubber



ZD-D020-F

.材质/Material: 铁 iron  
.表面处理/Finish: 金色 gold  
.高度/Height: 130mm  
.厚度/thickness: 1.8mm  
.底胶/Bottom rubber: 白胶 white rubber



ZD-D020-G

.材质/Material: 铁 iron  
.表面处理/Finish: 金色 gold  
.高度/Height: 130mm  
.厚度/thickness: 1.8mm  
.底胶/Bottom rubber: 白胶 white rubber



ZD-D020-H

.材质/Material: 铁 iron  
.表面处理/Finish: 金色 gold  
.高度/Height: 130mm  
.厚度/thickness: 1.8mm  
.底胶/Bottom rubber: 白胶 white rubber



ZD-E001(两头封圆头)

.材质/Material: 铁 iron  
.表面处理/Finish: 镀铬 Chrome plated  
.高度/Height: 40, 50mm  
.厚度/thickness: 0.8, 1.0mm  
.长度/Length: 100, 120, 130, 170, 200, 240mm  
.底胶/Bottom rubber: 白胶 white rubber



ZD-E系列



ZD-E003

.材质/Material: 铁 iron  
.表面处理/Finish: 镀铬 Chrome plated  
.管径/Tube Diameter: 40mm  
.厚度/thickness: 0.8mm  
.长度/Length: 150, 170, 180, 220, 250mm  
.底胶/Bottom rubber: 白胶 white rubber



ZD-E005(50半圆管V字头两头封)

.材质/Material: 铁 iron  
.表面处理/Finish: 金色、镀铬、黑色、玫瑰金 gold, Chrome plated, black, Rose gold  
.高度/Height: 55mm  
.厚度/thickness: 1.2mm  
.边长/Length: 150\*150mm  
.底胶/Bottom rubber: 白胶 white rubber



ZD-E005-A(38半圆管V字头两头封)

.材质/Material: 铁 iron  
.表面处理/Finish: 金色、镀铬、黑色、玫瑰金 gold, Chrome plated, black, Rose gold  
.高度/Height: 45mm 厚度/thickness: 1.2mm  
.边长/Length: 120\*120mm  
.底胶/Bottom rubber: 白胶 white rubber



ZD-E005-B

.材质/Material: 铁 iron  
.表面处理/Finish: 镀铬、黑色、金色、玫瑰金 Chrome plated, black, gold, Rose gold  
.高度/Height: 55mm 厚度/Thickness: 1.2mm  
.边长/Length: 150\*150mm  
.底胶/Base Rubber: 白胶 white rubber



ZD-E007

.材质/Material: 铁 iron  
.表面处理/Finish: 镀铬 Chrome plated  
.高度/Height: 30mm 厚度/Thickness: 1.0mm  
.边长/Length: 150\*150mm  
.底胶/Base Rubber: 白胶 white rubber



ZD-E系列



**ZD-E008**

.材质/Material: 铁 iron  
.表面处理/Finish: 镀铬、黑色、金色、玫瑰金  
Chrome plated, black, gold, Rose gold  
.高度/Height: 55mm 厚度/Thickness: 1.2mm  
.边长/length: 120\*120, 150\*150mm  
.底座/Base Rubber: 白胶粒 white rubber



**ZD-E009-A(一字脚)**

.材质/Material: 不锈钢 stainless steel  
.表面处理/Finish: 枪黑、金色 gun black, gold  
.高/height: 50 mm 宽度/Width: 30mm  
.边长/length: 150mm  
.厚度/Thickness: 1.0mm



**ZD-E009-B(一字脚)**

.材质/Material: 不锈钢 stainless steel  
.表面处理/Finish: 镀铬 chrome plated  
.高/height: 30mm 宽度/Width: 40mm  
.边长/length: 140mm  
.厚度/Thickness: 1.0mm



**ZD-E010-A**

.材质/Material: 不锈钢 stainless steel  
.表面处理/Finish: 枪黑、金色 gun black, gold  
.高/height: 30 mm 宽度/Width: 50mm  
.边长/length: 150\*150 mm  
.厚度/Thickness: 1.0mm



**ZD-E010-B**

.材质/Material: 不锈钢 stainless steel  
.表面处理/Finish: 枪黑、金色 gun black, gold  
.高/height: 55mm 宽度/Width: 25mm  
.边长/length: 150\*150 mm  
.厚度/Thickness: 1.0mm



**ZD-E010-C**

.材质/Material: 不锈钢 stainless steel  
.表面处理/Finish: 镀铬 chrome plated  
.高/height: 30mm 宽度/Width: 40mm  
.边长/length: 140\*140 mm  
.厚度/Thickness: 1.0mm



**ZD-E011**

.材质/Material: 不锈钢 stainless steel  
.表面处理/Finish: 金色 gold  
.高/height: 240mm  
.厚度/Thickness: 1.0mm



**ZD-E014**

.材质/Material: 不锈钢 stainless steel  
.表面处理/Finish: 镀铬 chrome plated  
.厚度/Thickness: 5.0mm  
.高/height: 110mm



**ZD-E015**

.材质/Material: 不锈钢 stainless steel  
.表面处理/Finish: 枪黑 Gun Black  
.高/height: 105mm 宽度/Width: 20mm  
.边长/length: 210mm

ZD-E系列



**ZD-E012**

.材质/Material: 不锈钢 stainless steel  
.表面处理/Finish: 金色 gold  
.高/height: 55mm  
.边长/length: 160\*210mm



**ZD-E016**

.材质/Material: 铁 iron  
.表面处理/Finish: 镀铬 Chrome plated  
.高度/Height: 235mm 厚度/Thickness: 2.0mm  
.顶板尺寸/Size of top plate: 70mm\*75mm

ZD-E系列



ZD-E017

.材质/Material: 不锈钢 stainless steel  
.表面处理/Finish: 黑色、镀铬、金色 black chrome plated, Gold  
.高度/height: 30mm 厚度/Thickness:1.0mm  
.边长/length: 130\*170mm  
.底胶/Base Rubber : 透明胶 transparent rubber



ZD-E019

.材质/Material: 不锈钢 stainless steel  
.表面处理/Finish: 黑色、镀铬、金色 black chrome plated, Gold  
.高度/Height: 45mm  
.边长/length: 220\*10mm  
.底胶/Base rubber : 白胶 white rubber



ZD-F001-B

.材质/Material: 铁 iron  
.表面处理/Finish: 黑色、镀铬、白色、金色、青铜、玫瑰金 black, chrome plated, white, gold, Bronze, rose gold  
.高度/Height :150mm  
.底胶/Base Rubber:白胶粒 white rubber



ZD-E018

.材质/Material: 不锈钢 stainless steel  
.表面处理/Finish: 金色 Gold  
.高度/Height: 230mm  
.底胶/Base rubber : 白胶 white rubber



ZD-F001-A

.材质/Material: 铁 iron  
.表面处理/Finish: 镀铬、黑色、白色、金色、青铜 chrome plated, black, white, gold, Bronze  
.规格/size: H140\*T1.2mm  
.底胶/Base Rubber:白胶粒 white rubber



ZD-F001-C

.材质/Material: 铁 iron  
.表面处理/Finish: 镀铬、黑色、白色、金色、青铜、玫瑰金 chrome plated, Black, white, gold, Bronze, Rose gold  
.高度/height: 130mm 厚度/ Thickness:1.2mm  
.底胶/Base Rubber : 透明胶 transparent rubber

ZD-F系列



ZD-F002

.材质/Material: 锌合金 Zinc alloy  
.表面处理/Finish: 镀铬 chrome plated  
.高度/height: 140mm  
.底胶/Base Rubber : 透明胶 transparent rubber



ZD-F003

.材质/Material: 锌合金 Zinc alloy  
.表面处理/Finish: 镀铬 chrome plated  
.高度/height: 100mm  
.底胶/Base Rubber : 透明胶 transparent rubber



ZD-F008

.材质/Material: 锌合金 Zinc alloy  
.表面处理/Finish: 镀铬 chrome plated  
.高度/height: 110mm  
.底胶/Base Rubber : 透明胶 transparent rubber



ZD-F009

.材质/Material: 锌合金 Zinc alloy  
.表面处理/Finish: 镀铬 chrome plated  
.高度/height: 120mm  
.底胶/Base Rubber : 透明胶 transparent rubber



ZD-F系列



**ZD-F010**

.材质/Material: 锌合金 Zinc alloy  
.表面处理/Finish: 镀铬 chrome plated  
.高度/height: 140mm  
.底座/Base Rubber: 透明胶 transparent rubber



**ZD-F012-A** 1.3寸有带空扁脚

.材质/Material: 锌合金 zinc alloy  
.表面处理/Finish: 镀铬 chrome plated  
.高度/height: 130mm  
.底座/Base Rubber: 透明胶 transparent rubber



**ZD-F014** 台湾平扁脚特大底

.材质/Material: 锌合金 zinc alloy  
.表面处理/Finish: 镀铬 chrome plated  
.高度/height: 100mm  
.底座/Base Rubber: 透明胶 transparent rubber



ZD-F系列



**ZD-F020** 扁刀脚

.材质/Material: 铁 iron  
.表面处理/Finish: 镀铬 chrome plated  
.高度/height: 100/130/150/180mm  
.底座/Base Rubber: 透明胶 transparent rubber



**ZD-F024**

.材质/Material: 锌合金 zinc alloy  
.表面处理/Finish: 镀铬 chrome plated  
.高度/height: 150/170/190mm  
.底座/Base Rubber: 透明胶 transparent rubber



**ZD-F025**

.材质/Material: 铁 iron  
.表面处理/Finish: 镀铬 chrome plated  
.高度/height: 100mm  
.厚度/thickness: 1.8mm  
.底座/Base rubber: 白胶 white rubber



**ZD-F012-B**

.材质/Material: 锌合金 zinc alloy  
.表面处理/Finish: 镀铬 chrome plated  
.高度/height: 200mm  
.底座/Base Rubber: 透明胶 transparent rubber



**ZD-F013** 台湾平扁脚特大底

.材质/Material: 锌合金 zinc alloy  
.表面处理/Finish: 镀铬 chrome plated  
.高度/height: 130mm  
.底座/Base Rubber: 透明胶 transparent rubber



**ZD-F029**

.材质/Material: 铁 iron  
.表面处理/Finish: 镀铬 chrome plated  
.高度/height: 120mm  
.厚度/thickness: 4.5mm  
.底座/Base rubber: 白胶 white rubber



**ZD-F029-A**

.材质/Material: 铁 iron  
.表面处理/Finish: 金色、镀铬 gold、chrome plated  
.高度/height: 100/120mm  
.厚度/thickness: 4.0、4.5mm  
.底座/Base Rubber: 白胶 white rubber

ZD-F系列



ZD-F030

.材质/Material: 铁 iron  
.表面处理/Finish: 镀铬 chrome plated  
.高度/height: 185mm  
.厚度/thickness: 1.4 mm  
.底胶/Base Rubber: 透明胶 transparent rubber

ZD-F系列



ZD-F034

.材质/Material: 塑料 Plastic  
.高度/height: 140, 190 mm



ZD-F035

.材质/Material: 塑料 Plastic  
.高度/height: 140, 170 mm



ZD-F031

.材质/Material: 塑料 Plastic  
.表面处理/Finish: 黑色、镀铬、金色 Black chrome plated, gold  
.高度/height: 130mm



ZD-F032

.材质/Material: 塑料 Plastic  
.表面处理/Finish: 黑色、镀铬、金色 Black chrome plated, gold  
.高度/height: 135mm



ZD-F036

.材质/Material: 塑料 Plastic  
.高度/height: 140, 180mm



ZD-F037

.材质/Material: 塑料 Plastic  
.高度/height: 145, 185 mm



ZD-F033

.材质/Material: 塑料 Plastic  
.表面处理/Finish: 黑色、镀铬、金色、白色、红色 Black, chrome plated, gold, white, red  
.高度/height: 95 mm



ZD-F038

.材质/Material: 塑料 Plastic  
.高度/height: 140, 180 mm





ZD-F系列



**ZD-F039**

.材质/Material: 塑料 Plastic  
.高度/height: 140、180 mm



**ZD-F040**

.材质/Material: 塑料 Plastic  
.高度/height: 60mm  
.边长/length: 110mm



**ZD-F041**

.材质/Material: 塑料 Plastic  
.高度/height: 60mm  
.边长/length: 110mm



**ZD-F042**

.材质/Material: 塑料 Plastic  
.高度/height: 60mm  
.边长/length: 110mm



**ZD-F043**

.材质/Material: 塑料 Plastic  
.高度/height: 60mm  
.边长/length: 110mm

ZD-PL系列



**ZD-PL01-A**

.材质/Material: 塑料 Plastic  
.表面处理/Finish: 黑色 black  
.规格/size:  $\Phi 45 \times H20$ 、 $\Phi 48 \times H25$ mm



**ZD-PL01-B**

.材质/Material: 塑料 Plastic  
.表面处理/Finish: 黑色 black  
.规格/size:  $\Phi 50 \times H40$ 、 $\Phi 50 \times H50$ mm  
.厚度/Thickness: 2.0、3.0mm



**ZD-PL01-C**

.材质/Material: 塑料 Plastic  
.表面处理/Finish: 黑色 black  
.规格/size:  $\Phi 55 \times H30$ mm



**ZD-PL01-D**

.材质/Material: 塑料 Plastic  
.表面处理/Finish: 黑色 black  
.规格/size:  $\Phi 59 \times H29$ mm



**ZD-PL01-E**

.材质/Material: 塑料 Plastic  
.表面处理/Finish: 黑色 black  
.规格/size:  $\Phi 60 \times H40$ mm、 $\Phi 51 \times H60$ mm

ZD-PL系列



**ZD-PL01-F/G**

.材质/Material: 塑料 Plastic  
.表面处理/Finish: 黑色 black  
.规格/size:  $\Phi 56^*H70$ 、 $\Phi 57^*H80mm$



**ZD-PL02-A**

.材质/Material: 塑料 Plastic  
.表面处理/Finish: 黑色 black  
.规格/size:  $\Phi 40^*H40mm$   
.螺杆直径/Screw diameter: M8



**ZD-PL02-F**

.材质/Material: 塑料 Plastic  
.表面处理/Finish: 黑色 black  
.规格/size:  $\Phi 88^*H100mm$   
.螺杆直径/Screw diameter: M10

ZD-PL系列



**ZD-PL03**

.材质/Material: 塑料 Plastic  
.表面处理/Finish: 黑色 black  
.规格/size:  $\Phi 80^*H80$ 、 $\Phi 88^*H100mm$



**ZD-PL02-B**

.材质/Material: 塑料 Plastic  
.表面处理/Finish: 黑色 black  
.规格/size:  $\Phi 50^*H50mm$   
.螺杆直径/Screw diameter: M8



**ZD-PL02-C**

.材质/Material: 塑料 Plastic  
.表面处理/Finish: 黑色 black  
.规格/size:  $\Phi 55^*H50$ 、 $\Phi 55^*H60mm$   
.螺杆直径/Screw diameter: M8



**ZD-PL04**

.材质/Material: 塑料 Plastic  
.表面处理/Finish: 黑色 black  
.规格/size:  $\Phi 73^*H60mm$



**ZD-PL05**

.材质/Material: 塑料 Plastic  
.表面处理/Finish: 黑色 black  
.规格/size:  $\Phi 33^*H31mm$



**ZD-PL02-D**

.材质/Material: 塑料 Plastic  
.表面处理/Finish: 黑色 black  
.规格/size:  $\Phi 58^*H80mm$   
.螺杆直径/Screw diameter: M8



**ZD-PL02-E**

.材质/Material: 塑料 Plastic  
.表面处理/Finish: 黑色 black  
.规格/size:  $\Phi 60^*H30$ 、 $\Phi 60^*H40$   $\Phi 60^*H50mm$   
.螺杆直径/Screw diameter: M8



**ZD-PL06-A**

.材质/Material: 塑料 Plastic  
.表面处理/Finish: 黑色 black  
.规格/size:  $\Phi 35^*H41mm$



**ZD-PL06-B**

.材质/Material: 塑料 Plastic  
.表面处理/Finish: 黑色 black  
.规格/size:  $\Phi 45^*H25mm$



ZD-PL系列



**ZD-PL07-A**

.材质/Material: 塑料 Plastic  
.表面处理/Finish: 黑色 black  
.规格/size:  $\Phi 33 \times H13$ ,  $\Phi 50 \times H22\text{mm}$



**ZD-PL07-B**

.材质/Material: 塑料 Plastic  
.表面处理/Finish: 黑色 black  
.规格/size:  $\Phi 31 \times H14$ ,  $\Phi 33 \times H13$ ,  $\Phi 50 \times H22\text{mm}$

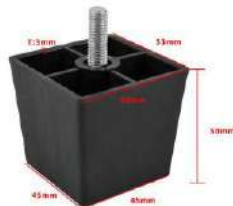

**ZD-PL11-A**

.材质/Material: 塑料 Plastic  
.表面处理/Finish: 黑色 black  
.规格/size:  $L53 \times 53 \times H50\text{mm}$   
.螺杆直径/Screw diameter: M8



**ZD-PL08-A/B**

.材质/Material: 塑料 Plastic  
.表面处理/Finish: 黑色 black  
.规格/size: H100, 115, 120, 130, 140, 150, 180, 200mm  
.螺杆直径/Screw diameter: M8, M10



Night Stand



Sofa



**ZD-PL11-B**

.材质/Material: 塑料 Plastic  
.表面处理/Finish: 黑色 black  
.规格/size:  $L65 \times 65 \times H115\text{mm}$   
.螺杆直径/Screw diameter: M8



**ZD-PL11-C**

.材质/Material: 塑料 Plastic  
.表面处理/Finish: 黑色 black  
.规格/size:  $L97 \times 97 \times H100\text{mm}$   
.螺杆直径/Screw diameter: M8



TV Stand



Bed



**ZD-PL10-A**

.材质/Material: 塑料 Plastic  
.表面处理/Finish: 黑色 black  
.规格/size:  $L98 \times 98 \times H50\text{mm}$



**ZD-PL10-B**

.材质/Material: 塑料 Plastic  
.表面处理/Finish: 黑色 black  
.边长/Length:  $150 \times 150\text{mm}$   
.高度/height: 45, 75 mm



**ZD-PL11-D**

.材质/Material: 塑料 Plastic  
.表面处理/Finish: 黑色 black  
.规格/size:  $L82 \times 82 \times H200\text{mm}$   
.螺杆直径/Screw diameter: M8



**ZD-PL11-E**

.材质/Material: 塑料 Plastic  
.表面处理/Finish: 黑色 black  
.规格/size:  $L83 \times 83 \times H160\text{mm}$   
.螺杆直径/Screw diameter: M8

ZD-PL系列

ZD-PL系列



**ZD-PL11-F**

.材质/Material: 塑料 Plastic  
.表面处理/Finish: 黑色 black  
.规格/size: L88\*88\*H30mm  
.螺杆直径/Screw diameter: M8



**ZD-PL12-D**

.材质/Material: 塑料 Plastic  
.表面处理/Finish: 黑色 black  
.规格/size: L75\*75\*H60mm



**ZD-PL14-B**

.材质/Material: 塑料 Plastic  
.表面处理/Finish: 黑色 black  
.规格/size: L162\*85\*H40mm



**ZD-PL14-C**

.材质/Material: 塑料 Plastic  
.表面处理/Finish: 黑色 black  
.规格/size: L90\*90\*H50mm



**ZD-PL12-E**

.材质/Material: 塑料 Plastic  
.表面处理/Finish: 黑色 black  
.高度/height: 80、100mm



**ZD-PL13-A**

.材质/Material: 塑料 Plastic  
.表面处理/Finish: 黑色 black  
.规格/size: L180\*90\*H55mm



**ZD-PL14-D**

.材质/Material: 塑料 Plastic  
.表面处理/Finish: 黑色 black  
.规格/size: L50\*50\*H50mm



**ZD-PL14-E**

.材质/Material: 塑料 Plastic  
.表面处理/Finish: 黑色 black  
.规格/size: L50\*50\*H25mm



**ZD-PL14-A**

.材质/Material: 塑料 Plastic  
.表面处理/Finish: 黑色 black  
.规格/size: L180\*150\*H72mm



**ZD-PL15-A**

.材质/Material: 塑料 Plastic  
.表面处理/Finish: 黑色 black  
.高度/height: 44mm





ZD-PL系列



**ZD-PL15-B**

.材质/Material: 塑料 Plastic  
.表面处理/Finish: 黑色 black  
.高度/height: 60mm



**ZD-PL15-G**

.材质/Material: 塑料 Plastic  
.表面处理/Finish: 黑色 black  
.高度/height: 35mm

ZD-PL系列



**ZD-PL15-H/I**

.材质/Material: 塑料 Plastic  
.表面处理/Finish: 黑色 black  
.高度/height: 35mm



**ZD-PL15-C**

.材质/Material: 塑料 Plastic  
.表面处理/Finish: 黑色 black  
.高度/height: 60mm



**ZD-PL15-D**

.材质/Material: 塑料 Plastic  
.表面处理/Finish: 黑色 black  
.高度/height: 35mm



**ZD-PL16**

.材质/Material: 铁 iron  
.规格/size: L98\*W20\*H28mm



**ZD-PL17**

.材质/Material: 铁 iron  
.高度/height: 28mm  
.边长/length: 98\*98mm



**ZD-PL15-E**

.材质/Material: 塑料 Plastic  
.表面处理/Finish: 黑色 black  
.高度/height: 35mm



**ZD-PL15-F**

.材质/Material: 塑料 Plastic  
.表面处理/Finish: 黑色 black  
.高度/height: 35mm



**ZD-PL18**

.材质/Material: 塑料 Plastic  
.边长/length: 45\*45mm



ZD-WL系列

ZD-WL系列



ZD-WL01

.材质/Material: 木 Wood  
.表面处理/Finish: brown 棕色  
.高度/height: 100、120 mm  
.螺杆直径/Screw diameter: M10



ZD-WL02

.材质/Material: 木 Wood  
.表面处理/Finish: brown 棕色  
.高度/height: 120 mm  
.螺杆直径/Screw diameter: M10  
.顶部尺寸/Top is : 65\*65mm 底部尺寸/bottom is : 43\*43mm



ZD-WL07

.材质/Material: 木 Wood  
.表面处理/Finish: brown 棕色  
.高度/height: 150 mm  
.螺杆直径/Screw diameter: M10  
.顶部尺寸/Top is: 63mm 底部尺寸/bottom is : 35mm



ZD-WL08

.材质/Material: 木 Wood  
.表面处理/Finish: shiny black 亮黑  
.高度/height: 200 mm  
.螺杆直径/Screw diameter: M10  
.顶部尺寸/Top is: 65mm 底部尺寸/bottom is : 33mm



ZD-WL03

.材质/Material: 木 Wood  
.表面处理/Finish: brown 棕色  
.高度/height: 120、180mm  
.螺杆直径/Screw diameter: M10  
.顶部尺寸/Top is: 60、69mm 底部尺寸/bottom is : 37mm



ZD-WL09

.材质/Material: 木 Wood  
.表面处理/Finish: matte white 白色  
.高度/height: 100 mm  
.螺杆直径/Screw diameter: M10  
.顶部尺寸/Top is: 52 mm 底部尺寸/bottom is : 31mm



ZD-WL10

.材质/Material: 木 Wood  
.表面处理/Finish: shiny black 亮黑色  
.高度/height: 140 mm  
.螺杆直径/Screw diameter: M10  
.顶部尺寸/Top is: 55 mm 底部尺寸/bottom is : 32mm



ZD-WL05

.材质/Material: 木 Wood  
.表面处理/Finish: shiny red brown 红棕色  
.高度/height: 130 mm  
.螺杆直径/Screw diameter: M10  
.顶部尺寸/Top is: 76mm 底部尺寸/bottom is : 35mm



ZD-WL06

.材质/Material: 木 Wood  
.表面处理/Finish: red brown 红棕色  
.高度/height: 120 mm  
.螺杆直径/Screw diameter: M10  
.顶部尺寸/Top is: 45mm 底部尺寸/bottom is : 30mm



ZD-WL11

.材质/Material: 木 Wood  
.表面处理/Finish: Matte black 哑黑色  
.高度/height: 120 mm  
.螺杆直径/Screw diameter: M10  
.顶部尺寸/Top is: 73 mm 底部尺寸/bottom is : 43mm



ZD-WL12

.材质/Material: 木 Wood  
.表面处理/Finish: wooden color+ golden copper cover  
本色 + 金铜套  
.高度/height: 100、120、150、200 mm  
.螺杆直径/Screw diameter: M10  
.顶部尺寸/Top is: 52 mm 底部尺寸/bottom is : 28mm



ZD-TL系列



ZD-TL07

.材质/Material: 201不锈钢 201 stainless steel  
.高度/height: 100mm  
.厚度/Thickness: 5.5mm



ZD-TL16

.材质/Material: 铝合金 Aluminum alloy  
.表面处理/Finish: 黑色、灰色 black、grey  
.规格/size: H720\*L1400\*W800, H720\*L1600\*W800, H720\*L2000\*W1000 mm.



ZD-TL17

.材质/Material: 铝合金 Aluminum alloy  
.表面处理/Finish: 白色 white  
.直径/Diameter: 180, 300mm  
.高度/height: 715mm



ZD-SH01

.材质/Material: 不锈钢stainless steel  
.表面处理/Finish: 金色 gold  
.规格/size:H 680\*L 820mm

ZD-SH系列



ZD-SH02

.材质/Material: 不锈钢stainless steel  
.表面处理/Finish: 金色、玫瑰金 gold、rose gold  
.规格/size:H:650mm \* L:250\*160mm



ZD-SH05

.材质/Material: 不锈钢stainless steel  
.表面处理/Finish: 镀铬、金色 chrome plated、gold  
.规格/size:600\*150, 850\*800mm  
.厚度/thickness: 2.0mm



ZD-SH08

.材质/Material: 不锈钢stainless steel  
.表面处理/Finish: 镀铬、金色 chrome plated、gold  
.规格/size:600\*150, 850\*800mm  
.厚度/thickness: 2.0mm

ZD-SH系列



ZD-SH11

.材质/Material: 不锈钢 stainless steel  
.表面处理/Finish: 金色 gold  
.规格/size: H:776\*L820mm



ZD-SH18

.材质/Material: 不锈钢 stainless steel  
.表面处理/Finish: 金色 gold  
.规格/size: H750\*L750\*W750mm

ZD-SH系列



ZD-SH19

.材质/Material: 不锈钢 stainless steel  
.表面处理/Finish: 金色 gold  
.规格/size: H750\*W730mm



ZD-SH12

.材质/Material: 不锈钢 stainless steel  
.表面处理/Finish: 金色 gold  
.规格/size: H600\*W170mm



ZD-SH20

.材质/Material: 不锈钢 stainless steel  
.表面处理/Finish: 金色 gold  
.规格/size: H750\*W740mm



ZD-SH13

.材质/Material: 不锈钢 stainless steel  
.表面处理/Finish: 金色 gold  
.规格/size: 680\*820mm



ZD-SH14

.材质/Material: 不锈钢 stainless steel  
.表面处理/Finish: 金色 gold  
.规格/size: 850\*520mm



ZD-SH22

.材质/Material: 不锈钢 stainless steel  
.表面处理/Finish: 金色 gold  
.规格/size: w680\*L820mm



ZD-SH23

.材质/Material: 不锈钢 stainless steel  
.表面处理/Finish: 金色 gold  
.规格/size: w680\*L820mm



ZD-SH系列



ZD-SH24

.材质/Material: 不锈钢stainless steel  
.表面处理/Finish: 金色 gold  
.规格/size:w770\*L820mm



ZD-SH25

.材质/Material: 不锈钢stainless steel  
.表面处理/Finish: 金色 gold  
.规格/size:w770\*L820mm



ZD-SH系列



ZD-SH31

.材质/Material: 不锈钢stainless steel  
.表面处理/Finish: 金色 gold  
.规格/size:L500\*W180\*T2.0mm



ZD-SH28

.材质/Material: 不锈钢stainless steel  
.表面处理/Finish: 金色 gold  
.规格/size:L500\*W180\*T2.0mm



ZD-SH32

.材质/Material: 不锈钢stainless steel  
.表面处理/Finish: 金色 gold  
.规格/size:L500\*W180\*T2.0mm



ZD-SH46

.材质/Material: 不锈钢 stainless steel  
.表面处理/Finish: 金色 gold  
.规格/size:800\*720\*750mm



ZD-SH29

.材质/Material: 不锈钢stainless steel  
.表面处理/Finish: 金色 gold  
.规格/size:L500\*W180\*T2.0mm



ZD-SH30

.材质/Material: 不锈钢stainless steel  
.表面处理/Finish: 金色 gold  
.规格/size:L500\*W180\*T2.0mm



ZD-SH47

.材质/Material: 不锈钢stainless steel  
.表面处理/Finish: 金色 gold  
.规格/size:845\*600\*250mm  
.管尺寸/pipe size :20mm



ZD-SH系列



ZD-SH48

.材质/Material: 不锈钢stainless steel  
.表面处理/Finish: 金色 gold  
.规格/size: 11750\*W660mm



ZD-SH49

.材质/Material: 不锈钢stainless steel  
.表面处理/Finish: 金色 gold  
.规格/size: 1800\*W250mm  
.管尺寸/pipe size :40\*20mm



ZD-SH57

.材质/Material: 201不锈钢 201 stainless steel  
.表面处理/Finish: 镀铬、金色 chrome plated、gold  
.规格/size: 740\*700mm  
.管尺寸/pipe size/:20\*20mm

ZD-SH系列



ZD-SH50

.材质/Material: 不锈钢stainless steel  
.表面处理/Finish: 金色 gold  
.规格/size: L705\*W700mm  
.管尺寸/pipe size :25\*25mm



ZD-SH55

.材质/Material: 不锈钢stainless steel  
.表面处理/Finish: 金色 gold  
.规格/size: 11600\*W800mm  
.厚度/Thickness :10mm



ZD-SH58

.材质/Material: 201不锈钢 201 stainless steel  
.表面处理/Finish: 金色 gold



ZD-SH56

.材质/Material: 不锈钢 stainless steel  
.表面处理/Finish: 镀铬、金色 chrome plated、gold、  
.规格/size: 500\*180mm  
.管尺寸/pipe size/:20\*20mm



ZD-SH59

.材质/Material: 201不锈钢 201stainless steel  
.表面处理/Finish: 金色 gold  
.高度/Height: 250 mm 宽度/Width:350mm  
.管尺寸/pipe size :20\*20mm





ZD-SH系列



ZD-SH60

.材质/Material: 201不锈钢 201 stainless steel  
.表面处理/Finish: 金色 gold



ZD-SH61

.材质/Material: 201不锈钢 201 stainless steel  
.表面处理/Finish: 枪黑 Gun Black  
.长度/length: 160mm



ZD-SH62

.材质/Material: 201不锈钢 201 stainless steel  
.表面处理/Finish: 枪黑 Gun Black  
.总高度/Total height: 340mm



ZD-SH63

.材质/Material: 201不锈钢 201 stainless steel  
.表面处理/Finish: 金色、枪黑 gold, Gun Black

ZD-SH系列



ZD-SH64

.材质/Material: 201不锈钢 201 stainless steel  
.表面处理/Finish: 金色 gold  
.总高度/Total height: 335mm



ZD-SH65

.材质/Material: 201不锈钢 201 stainless steel  
.表面处理/Finish: 黑色、金色 Black、Gold  
.尺寸/size: 1500\*W30 MM



ZD-SH66

.材质/Material: 201不锈钢 201 stainless steel  
.表面处理/Finish: 金色 Gold  
.尺寸/size: 485\*180\*40.5, 555\*160\*60MM  
.管径/Tube size: 20\*10MM



ZD-SH67

.材质/Material: 201不锈钢 201 stainless steel  
.表面处理/Finish: 金色 Gold  
.尺寸/size: 435\*110\*290MM  
.管径/Tube size: 20\*10MM



ZD-SH系列



ZD-SH68

.材质/Material: 不锈钢 stainless steel  
.表面处理/Finish: 金色 gold  
.高度/height: 60mm  
.螺丝/Screws: M8



ZD-SH69

.材质/Material: 不锈钢 stainless steel  
.表面处理/Finish: 金色 gold  
.高度/height: 60mm



ZD-SH70

.材质/Material: 铁 Iron  
.表面处理/Finish: 金色 Gold  
.尺寸/size:  $\Phi 12 \times 400$ ,  $\Phi 12 \times 500$ ,  $\Phi 12 \times 605$ MM



ZD-SH71

.材质/Material: 不锈钢 stainless steel  
.表面处理/Finish: 金色 Gold  
.高度/Height: 280 mm 长度/length: 380mm  
.管尺寸/pipe size : 20mm



ZD-SH72

.材质/Material: 不锈钢 stainless steel  
.表面处理/Finish: 金色 Gold  
.长度/length: 600 mm  
.管尺寸/pipe size : 25mm



ZD-SH系列



ZD-SH73

.材质/Material: 不锈钢 stainless steel  
.总高度/Total height: 710mm  
.长度/length: 800mm  
.管尺寸/pipe size : 25mm



ZD-SH74

.材质/Material: 不锈钢+木 stainless steel + wood  
.总高度/Total height: 720mm  
.长度/length: 800mm





ZD-SH系列



ZD-SH76

.材质/Material: 不锈钢 stainless steel  
.表面处理/Finish: 金色 gold  
.高度/height: 170mm  
.宽度/width: 900mm



ZD-SH系列



ZD-SH80

.材质/Material: 不锈钢 stainless steel  
.表面处理/Finish: 金色、镀铬 gold、Chrome plated  
.高度/height: 640mm  
.管规格/Tube Size: 32mm



ZD-SH77

.材质/Material: 不锈钢 stainless steel  
.表面处理/Finish: 金色 gold  
.规格/size: H1180\*W180\*L880mm



ZD-SH81-A

.材质/Material: 不锈钢 stainless steel  
.表面处理/Finish: 金色 gold



ZD-SH81-B

.材质/Material: 不锈钢 stainless steel  
.表面处理/Finish: 金色 gold



ZD-SH79

.材质/Material: 不锈钢 stainless steel  
.表面处理/Finish: 金色、镀铬 gold、Chrome plated



ZD-AS系列



ZD-AS01

- . 材质/Material: 亚克力 acrylic
- . 表面处理/Finish: 透明 Transparent
- . 总高度/Total Height: 150mm
- . 螺丝/Screw: M8
- . 底胶/Bottom Rubber: 白胶 white rubber



ZD-AS02

- . 材质/Material: 亚克力 acrylic
- . 表面处理/Finish: 透明 Transparent
- . 总高度/Total Height: 80mm, 100mm, 120mm, 150, mm
- . 螺丝/Screw: M8
- . 底胶/Bottom Rubber: 白胶 white rubber



ZD-AS07

- . 材质/Material: 亚克力 acrylic
- . 表面处理/Finish: 透明 Transparent
- . 总高度/Total Height: 100mm
- . 螺丝/Screw: M8
- . 底胶/Bottom Rubber: 白胶 white rubber



ZD-AS08

- . 材质/Material: 亚克力 acrylic
- . 表面处理/Finish: 透明 Transparent
- . 总高度/Total Height: 150mm
- . 螺丝/Screw: M8
- . 底胶/Bottom Rubber: 白胶 white rubber



ZD-AS03

- . 材质/Material: 亚克力 acrylic
- . 表面处理/Finish: 透明 Transparent
- . 总高度/Total Height: 120mm
- . 螺丝/Screw: M10
- . 底胶/Bottom Rubber: 白胶 white rubber



ZD-AS04

- . 材质/Material: 亚克力 acrylic
- . 表面处理/Finish: 透明 Transparent
- . 总高度/Total Height: 180
- . 螺丝/Screw: M8
- . 底胶/Bottom Rubber: 白胶 white rubber

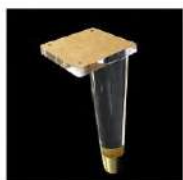

ZD-AS09

- . 材质/Material: 亚克力 acrylic
- . 表面处理/Finish: 透明 Transparent
- . 总高度/Total Height: 100, 120, , 150, 205mm
- . 螺丝/Screw: M8
- . 底胶/Bottom Rubber: 黑胶 Black rubber



ZD-AS09-1

- . 材质/Material: 亚克力 acrylic
- . 表面处理/Finish: 透明 Transparent
- . 规格/Size:  $\phi 37 * H120mm$
- . 顶板尺寸/Size of top plate:  $70 * 70 * 10mm$
- . 底胶/Bottom Rubber: 白胶 White rubber



ZD-AS05

- . 材质/Material: 亚克力 acrylic
- . 表面处理/Finish: 透明 Transparent
- . 总高度/Total Height: 120mm
- . 螺丝/Screw: M8
- . 底胶/Bottom Rubber: 白胶 white rubber



ZD-AS06

- . 材质/Material: 亚克力 acrylic
- . 表面处理/Finish: 透明 Transparent
- . 总高度/Total Height: 50mm
- . 螺丝/Screw: M8



ZD-AS09-2

- . 材质/Material: 亚克力 acrylic
- . 表面处理/Finish: 透明 Transparent
- . 规格/Size:  $\phi 37 * H200mm$
- . 顶板尺寸/Size of top plate:  $70 * 70 * 10mm$
- . 底胶/Bottom Rubber: 白胶 White rubber



ZD-AS09-3

- . 材质/Material: 亚克力 acrylic
- . 表面处理/Finish: 透明 Transparent
- . 规格/Size:  $H200 * L90mm$
- . 底胶/Bottom Rubber: 白胶 White rubber



ZD-AS系列

ZD-AS系列



ZD-AS09-4

- . 材质/Material: 亚克力 acrylic
- . 表面处理/Finish 透明 Transparent
- . 总高度/Total Height: 120mm
- . 底胶/Bottom Rubber: 白胶 White rubber



ZD-AS09-5

- . 材质/Material: 亚克力 acrylic
- . 表面处理/Finish 透明 Transparent
- . 总高度/Total Height: 152, 162, 200mm
- . 顶板尺寸/Size of top plate: 70\*70\*10mm
- . 底胶/Bottom Rubber: 黑胶 Black rubber



ZD-AS12

- . 材质/Material: 亚克力 acrylic
- . 表面处理/Finish 透明 Transparent
- . 总高度/Total Height: 150mm、螺丝/Screw: M8
- . 底胶/Bottom Rubber: 白胶 White rubber



ZD-AS13

- . 材质/Material: 亚克力 acrylic
- . 表面处理/Finish 透明 Transparent
- . 总高度/Total Height: 155mm
- . 螺丝/Screw: M8
- . 底胶/Bottom Rubber: 白胶 White rubber

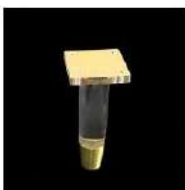

ZD-AS09-6

- . 材质/Material: 亚克力 acrylic
- . 表面处理/Finish 透明 Transparent
- . 规格/Size: H150mm
- . 顶板尺寸/Size of top plate: 70\*70\*10mm
- . 底胶/Bottom Rubber: 白胶 White rubber



ZD-AS10

- . 材质/Material: 亚克力 acrylic
- . 表面处理/Finish 透明 Transparent
- . 总高度/Total Height: 100, 120, 150mm、上直径/Upper diameter: 5\*7mm
- . 下直径/Down diameter: 5\*5mm、螺丝/Screw: M8
- . 底胶/Bottom Rubber: 白胶 White rubber



ZD-AS14

- . 材质/Material: 亚克力 acrylic
- . 表面处理/Finish 透明 Transparent
- . 总高度/Total Height: 130mm
- . 螺丝/Screw: M8
- . 底胶/Bottom Rubber: 白胶 White rubber



ZD-AS11

- . 材质/Material: 亚克力 acrylic
- . 表面处理/Finish 透明 Transparent
- . 总高度/Total Height: 100, 120, 150mm、上直径/Upper diameter: 5mm
- . 下直径/Down diameter: 3mm、螺丝/Screw: M8
- . 底胶/Bottom Rubber: 白胶 White rubber



ZD-AS15

- . 材质/Material: 亚克力 acrylic
- . 表面处理/Finish 透明 Transparent
- . 总高度/Total Height: 180mm
- . 螺丝/Screw: M8
- . 底胶/Bottom Rubber: 白胶 White rubber



ZD-AS16

- . 材质/Material: 亚克力 acrylic
- . 表面处理/Finish 透明 Transparent
- . 总高度/Total Height: 100mm
- . 螺丝/Screw: M8
- . 底胶/Bottom Rubber: 白胶 White rubber

ZD-AS系列



ZD-AS17

. 材质/Material: 亚克力 acrylic  
. 表面处理/Finish 透明 Transparent  
. 总高度/Total Height: 125mm 螺丝/Screw: M8  
. 底胶/Bottom Rubber: 白胶 White rubber



ZD-AS18

. 材质/Material: 亚克力 acrylic  
. 表面处理/Finish 透明 Transparent 螺丝/Screw: M8  
. 总高度/Total Height: 180mm  
. 底胶/Bottom Rubber: 锌合金套筒 Zinc alloy sleeve



ZD-AS23

. 材质/Material: 亚克力 acrylic  
. 表面处理/Finish 透明 Transparent  
. 总高度/Total Height: 180mm 螺丝/Screw: M8  
. 底胶/Bottom Rubber: 白胶 White rubber



ZD-AS24

. 材质/Material: 亚克力 acrylic  
. 表面处理/Finish 透明 Transparent  
. 总高度/Total Height: 140mm 螺丝/Screw: M8  
. 底胶/Bottom Rubber: 白胶 White rubber



ZD-AS19

. 材质/Material: 亚克力 acrylic  
. 表面处理/Finish 透明 Transparent  
. 总高度/Total Height: 220, 240mm 螺丝/Screw: M8  
. 底胶/Bottom Rubber: 锌合金套筒 Zinc alloy sleeve



ZD-AS20

. 材质/Material: 亚克力 acrylic  
. 表面处理/Finish 透明 Transparent  
. 总高度/Total Height: 180mm 螺丝/Screw: M8  
. 底胶/Bottom Rubber: 锌合金套筒 Zinc alloy sleeve



ZD-AS21

. 材质/Material: 亚克力 acrylic  
. 表面处理/Finish 透明 Transparent  
. 总高度/Total Height: 180mm 螺丝/Screw: M8  
. 底胶/Bottom Rubber: 锌合金套筒 Zinc alloy sleeve



ZD-AS22

. 材质/Material: 亚克力 acrylic  
. 表面处理/Finish 透明 Transparent  
. 总高度/Total Height: 140mm 螺丝/Screw: M8  
. 底胶/Bottom Rubber: 白胶 White rubber





ZD-H系列



ZD-H006

.材质/Material: iron (铁)  
.表面处理/Finish: 镀白锌 white zinc plated  
.规格/size: 90°、117°、135°、165°、180°、225°



ZD-H007

.材质/Material: iron (铁)  
.表面处理/Finish: 镀白锌 white zinc plated  
.规格/size: 90°、105°、135°、165°、180°



ZD-H系列



ZD-H010

.材质/Material: iron (铁)  
.表面处理/Finish: 镀白锌 white zinc plated  
.规格/size: 90°、135°、165°、180°



ZD-H007-A

.材质/Material: iron (铁)  
.表面处理/Finish: 镀白锌 white zinc plated  
.规格/size: 90°、105°、135°、165°、180°



ZD-H011 (曲铰)

.材质/Material: iron (铁)  
.表面处理/Finish: 镀白锌 white zinc plated



ZD-H012 (二节铰)

.材质/Material: iron (铁)  
.表面处理/Finish: 镀白锌 white zinc plated



ZD-H008

.材质/Material: iron (铁)  
.表面处理/Finish: 镀白锌 white zinc plated  
.规格/size: 90°、105°、135°、165°、180°



ZD-H008-A

.材质/Material: iron (铁)  
.表面处理/Finish: 镀白锌 white zinc plated  
.规格/size: 90°、135°、180°



ZD-H013-A

.材质/Material: iron (铁)  
.表面处理/Finish: 镀白锌 white zinc plated



ZD-H013-B

.材质/Material: iron (铁)  
.表面处理/Finish: 镀白锌 white zinc plated

ZD-I系列



**ZD-I001-A** 黑铰

.材质/Material: 铁 iron  
.表面处理/Finish: 电泳黑色 Electrophoresis black  
.厚度/Thickness: 1.8、3.0MM



**ZD-I001-B** 白铰

.材质/Material: 铁 iron  
.表面处理/Finish: 白色喷粉 white powder coated  
.厚度/Thickness: 1.8、2.0MM



**ZD-I001-E**

.材质/Material: 铁 iron  
.表面处理/Finish: 镀彩锌 / 黑色 Color zinc plated/black  
.厚度/Thickness: 1.8、2.0MM

ZD-I系列



**ZD-I003**

.材质/Material: 铁 iron  
.表面处理/Finish: 镀彩锌 Color zinc plated  
.长度/length: 260MM  
.厚度/Thickness: 2.3MM



**ZD-I001-C**

.材质/Material: 铁 iron  
.表面处理/Finish: 镀镍 Nickel plated  
.厚度/Thickness: 1.8、2.0MM

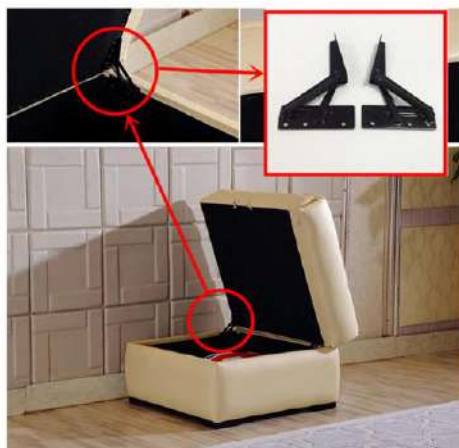

**ZD-I004-A**

.材质/Material: 铁 iron  
.表面处理/Finish: 镀彩锌 / 黑色 Color zinc plated/black  
.长度/length: 235MM  
.厚度/Thickness: 2.3MM



**ZD-I001-D**

.材质/Material: 铁 iron  
.表面处理/Finish: 镀白锌 white zinc plated  
.厚度/Thickness: 1.8、2.0MM



**ZD-I004-B**

.材质/Material: 铁 iron  
.表面处理/Finish: 镀彩锌/电泳黑  
Color zinc plated/Electrophoresis black  
.长度/length: 260MM  
.厚度/Thickness: 2.0MM



**ZD-I004-C**

.材质/Material: 铁 iron  
.表面处理/Finish: 镀彩锌 Color zinc plated  
.长度/length: 305MM  
.厚度/Thickness: 2.0、2.3 MM



ZD-I系列



**ZD-I005**

.材质/Material: 铁 iron  
.表面处理/Finish: 镀彩锌 Color zinc plated



**ZD-I006-B**茶几升降器 (带液压杆)

.材质/Material: 铁 iron  
.表面处理/Finish: 黑色喷粉 Black powder coated



ZD-I系列



**ZD-I006** Z型茶几升降器

.材质/Material: 铁 iron  
.表面处理/Finish: 黑色喷粉 Black powder coated



**ZD-I006-C**

.材质/Material: 铁 iron  
.表面处理/Finish: 黑色喷粉 Black powder coated



**ZD-I007** 千秋铰

.材质/Material: 铁 iron  
.表面处理/Finish: 黑色喷粉 Black powder coated



**ZD-I006-A**茶几升降器 (带弹簧)

.材质/Material: 铁 iron  
.表面处理/Finish: 黑色喷粉 Black powder coated



**ZD-I007-A** 白锌千秋铰

.材质/Material: 铁 iron  
.表面处理/Finish: 镀白锌 white zinc plated



ZD-I系列



**ZD-I007-B**

.材质/Material: 铁 iron  
.表面处理/Finish: 黑色喷粉, 灰色 black powder coated, Grey



**ZD-I008-A 摇臂铰**

.材质/Material: 铁 iron  
.表面处理/Finish: 黑色喷粉 Black powder coated



**ZD-I009-A (一字撑杆)**

.材质/Material: 铁 iron  
.表面处理/Finish: 镀白锌、黑色喷粉、镀锌 white zinc plated, black powder coated, Color zinc plated  
.规格/size: 4档、5档、7档、10档 4/5/7/10positions  
.备注/Remark: 可配角码 corner available



ZD-I系列



**ZD-I010 茶几铰**

.材质/Material: 铁 iron  
.表面处理/Finish: 黑色喷粉 Black powder coated



**ZD-I011 (小款床箱铰)**

.材质/Material: 铁 iron  
.表面处理/Finish: 电泳黑色 Electrophoresis black  
.厚度/Thickness: 3.0、4.0mm



**ZD-I011-A**

.材质/Material: 铁 iron  
.表面处理/Finish: 电泳黑色 electrophoresis black  
.厚度/Thickness: 2.5mm and 4.0mm



ZD-I系列



ZD-I011-B

材质/Material: 铁 iron  
表面处理/Finish: 电泳黑色 electrophoresis black  
厚度/Thickness: 4.0mm



ZD-I012-C

材质/Material: 铁 iron  
表面处理/Finish: 电泳黑色 electrophoresis black  
厚度/Thickness: 2.0mm and 3.0mm

ZD-I系列



ZD-I013大球铰

材质/Material: 铁 iron  
表面处理/Finish: 电泳黑色 electrophoresis black  
厚度/Thickness: 3.0mm and 4.0mm



ZD-I012(小款)

材质/Material: 铁 iron  
表面处理/Finish: 电泳黑色 electrophoresis black  
厚度/Thickness: 3.0mm and 4.0mm



ZD-I013-C1(大款)

材质/Material: 铁 iron  
表面处理/Finish: 白色喷粉 White Powder coated  
厚度/Thickness: 4.0mm



ZD-I012-B

材质/Material: 铁 iron  
表面处理/Finish: 电泳黑色 electrophoresis black  
厚度/Thickness: 3.0mm and 4.0mm



ZD-I013-C2(小款)

材质/Material: 铁 iron  
表面处理/Finish: 白色喷粉 White Powder coated  
厚度/Thickness: 4.0mm



ZD-I014

材质/Material: 铁 iron  
表面处理/Finish: 白色喷粉 White Powder coated  
规格/size : 600/900/1100/1200/1500mm

ZD-I系列



**ZD-I014-A**

.材质/Material: 铁 iron  
.表面处理/Finish: 黑色 black  
.规格/size: 620mm



**ZD-I014-A1**

.材质/Material: 铁 iron  
.表面处理/Finish: 黑色 black  
.规格/size: 520mm



ZD-I系列



**ZD-I014-B(平行气动杆支架)**

.材质/Material: 铁 iron  
.表面处理/Finish: 电泳黑色 electrophoresis black  
.厚度/Thickness: 4.0 & 5.0mm  
.长度/Length: 1500mm



**ZD-I014-C(电动杆支架)**

.材质/Material: 铁 iron  
.表面处理/Finish: 电泳黑色 electrophoresis black  
.厚度/Thickness: 4.0 & 5.0mm  
.长度/Length: 1500mm



**ZD-I014-D**

.材质/Material: 铁 iron  
.表面处理/Finish: 黑色 black



**ZD-I014-A2**

.材质/Material: 铁 iron  
.表面处理/Finish: 黑色 black  
.规格/size: 520mm



ZD-I系列



**ZD-I014-F**

.材质/Material: 铁 iron  
.表面处理/Finish: 黑色 black  
.规格/size: 1070mm



**ZD-I014-S (安全相支撑架)**

.材质/Material: 铁 iron  
.表面处理/Finish: 黑色 black  
.规格/size: 1200/1500mm



**ZD-I015 (平移铰)**

.材质/Material: 铁 iron  
.表面处理/Finish: 黑色喷粉+镀铬  
black powder coated+chrome plated  
.高度/Height: 230mm



**ZD-I016 (平移铰)**

.材质/Material: 铁 iron  
.表面处理/Finish: 黑色喷粉+镀铬  
black powder coated+chrome plated  
.高度/Height: 282mm

ZD-I系列

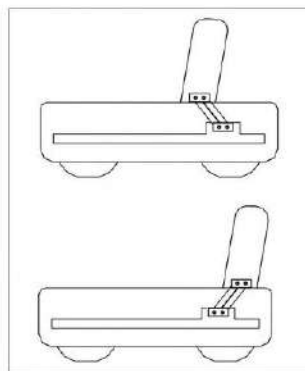

**ZD-I017 (平移铰)**

.材质/Material: 铁 iron  
.表面处理/Finish: 镀白锌 white zinc plated  
.高度/Height: 230mm



**ZD-I018 (平移铰)**

.材质/Material: 铁 iron  
.表面处理/Finish: 黑色喷粉+镀铬  
black powder coated+chrome plated  
.高度/Height: 282mm



**ZD-I020 (大日本相5档90度或180度)**

.材质/Material: 铁 iron  
.表面处理/Finish: 铁原色、镀白锌  
original color, white zinc plated  
.管径/Tube Diameter: 21mm



ZD-I系列

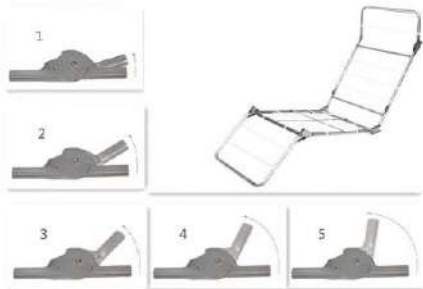

**ZD-I021-A** (小日本加5°90度)

.材质/Material: 铁 iron  
.表面处理/Finish: 铁原色、镀白锌  
original color, white zinc plated  
.管径/Tube Diameter: 15mm



**ZD-I021-B** 小日本加5°90度

.材质/Material: 铁 iron  
.表面处理/Finish: 铁原色/镀白锌  
original color/white zinc plated  
.管径/Tube Diameter: 15mm



**ZD-I022** 小日本加2°90° 4°90°

.材质/Material: 铁 iron  
.表面处理/Finish: 铁原色/镀白锌  
original color/white zinc plated  
.管径/Tube Diameter: 15mm



**ZD-I023** 三叉日本用

.材质/Material: 铁 iron  
.表面处理/Finish: 铁原色/镀白锌  
original color/white zinc plated  
.管径/Tube Diameter: 15mm



**ZD-I024**

.材质/Material: 铁 iron  
.表面处理/Finish: 灰色 Grey



**ZD-I025-B**

.材质/Material: 铁 iron  
.表面处理/Finish: 黑色、灰色 black、Grey



**ZD-I025-C**

.材质/Material: 铁 iron  
.表面处理/Finish: 黑色、白色 black、white

ZD-I系列



**ZD-I025-A**

.材质/Material: 铁 iron  
.表面处理/Finish: 白色、黑色 white、black



**ZD-I026**

.材质/Material: 铁 iron  
.表面处理/Finish: 黑色 black





**ZD-1027**

.材质/Material: 铁 iron  
.表面处理/Finish: 灰色 Grey



ZD-1系列



**ZD-1049**

.材质/Material: 铁 iron  
.表面处理/Finish: 黑色 black  
.规格/size: 1.4M、1.5M



**ZD-I028-A**

.材质/Material: 铁 iron  
.表面处理/Finish: 黑色、白色、灰色 black, white, Grey



**ZD-I029**

.材质/Material: 铁 iron  
.表面处理/Finish: 灰色 Grey



**ZD-I050**

.材质/Material: 铁 iron  
.表面处理/Finish: 黑色 black  
.规格/size: 1240\*635\*730、635\*330\*1080mm



**ZD-I030**

.材质/Material: 铁 iron  
.表面处理/Finish: 黑色 black  
.长度/Length: 450、560、660mm



**ZD-I051**

.材质/Material: 铁 iron  
.表面处理/Finish: 黑色 black  
.规格/size: 285\*373mm

ZD-I系列

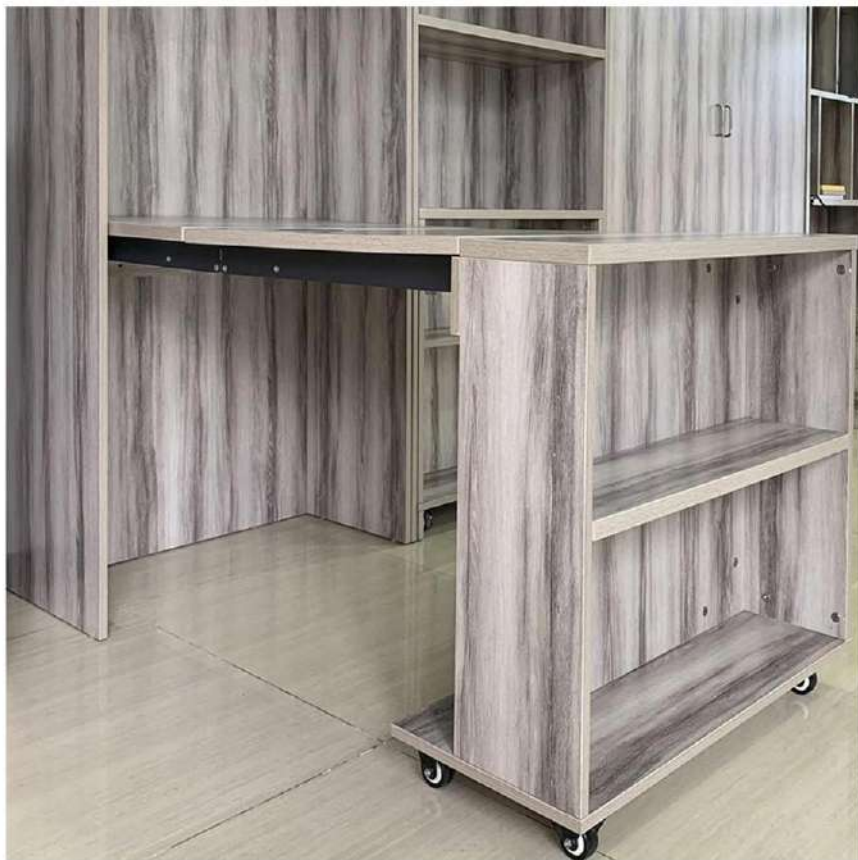

**ZD-I052**

.材质/Material: 铁 iron  
.表面处理/Finish: 黑色 black  
.规格/size: 376\*283mm



**ZD-I053**

.材质/Material: 不锈钢 stainless steel  
.表面处理/Finish: 灰色 grey



**ZD-I054**

.材质/Material: 铁 iron  
.表面处理/Finish: 黑色 black



**ZD-I055**

.材质/Material: 铁 iron  
.表面处理/Finish: 黑色 black



**ZD-I062**

.材质/Material: 铁 iron  
.表面处理/Finish: 镀锌白 zinc plated  
.规格/size: 410\*190mm

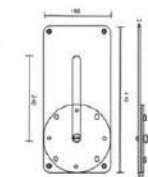

ZD-I系列





ZD-J系列



**ZD-J001**大耳升降 (长套筒)

.材质/Material: 铁 iron  
.表面处理/Finish: 镀白锌+镀铬  
white zinc plated+chrome plated



**ZD-J002**大耳升降 (短套筒)

.材质/Material: 铁 iron  
.表面处理/Finish: 镀白锌+镀铬  
white zinc plated+chrome plated



**ZD-J003**小耳升降 (短套筒)

.材质/Material: 铁 iron  
.表面处理/Finish: 镀白锌+镀铬  
white zinc plated+chrome plated



**ZD-J004**大耳架螺杆

.材质/Material: 铁 iron  
.表面处理/Finish: 镀白锌+镀铬  
white zinc plated+chrome plated



**ZD-J004-A**大耳架螺杆(长支)

.材质/Material: 铁 iron  
.表面处理/Finish: 镀白锌+镀铬  
white zinc plated+chrome plated



**ZD-J007**小耳架螺杆

.材质/Material: 铁 iron  
.表面处理/Finish: 镀白锌+镀铬  
white zinc plated+chrome plated



**ZD-J008**双耳架升降 (短套筒)

.材质/Material: 铁 iron  
.表面处理/Finish: 镀白锌+镀铬  
white zinc plated+chrome plated



**ZD-J005**大耳架带套筒

.材质/Material: 铁 iron  
.表面处理/Finish: 镀白锌+镀铬  
white zinc plated+chrome plated



**ZD-J007-A**(小耳架螺杆)

.材质/Material: 铁 iron  
.表面处理/Finish: 镀白锌+镀铬  
white zinc plated+chrome plated



**ZD-J009**双耳架螺杆

.材质/Material: 铁 iron  
.表面处理/Finish: 镀白锌+镀铬  
white zinc plated+chrome plated

## ZD-J系列

**ZD-J009-A**单耳朵螺柱

.材质/Material: 铁 iron  
.表面处理/Finish: 镀白锌+镀铬  
white zinc plated+chrome plated  
.备注/Remark:配螺柱 with threaded rod

**ZD-J010**双耳朵带套筒

.材质/Material: 铁 iron  
.表面处理/Finish: 镀白锌+镀铬  
white zinc plated+chrome plated  
.备注/Remark:配锌合金套筒with zinc alloy sleeves

**ZD-J013**配扁铁

.材质/Material: 铁 iron  
.表面处理/Finish: 镀白锌+镀铬  
white zinc plated+chrome plated  
.备注/Remark:配扁铁 with connecting plate

## ZD-J系列

**ZD-J013-A**配螺柱

.材质/Material: 铁 iron  
.表面处理/Finish: 镀白锌+镀铬  
white zinc plated+chrome plated  
.备注/Remark:配螺柱 with threaded rod

**ZD-J011**大耳朵带套筒 (短支长杆)

.材质/Material: 铁 iron  
.表面处理/Finish: 镀白锌+镀铬  
white zinc plated+chrome plated  
.备注/Remark:配锌合金套筒with zinc alloy sleeves

**ZD-J012**大耳朵带套筒 (长支)

.材质/Material: 铁 iron  
.表面处理/Finish: 镀白锌+镀铬  
white zinc plated+chrome plated  
.备注/Remark:配锌合金套筒with zinc alloy sleeves

**ZD-J013-A**配套筒

.材质/Material: 铁 iron  
.表面处理/Finish: 镀白锌+镀铬  
white zinc plated+chrome plated  
.备注/Remark:配锌合金套筒with zinc alloy sleeves

**ZD-J013-A**

.材质/Material: 铁 iron  
.表面处理/Finish: 镀白锌+镀铬  
white zinc plated+chrome plated  
.备注/Remark:配扁铁 with connecting plate

**ZD-J013**配螺柱

.材质/Material: 铁 iron  
.表面处理/Finish: 镀白锌+镀铬  
white zinc plated+chrome plated  
.备注/Remark:配螺柱 with threaded rod

**ZD-J013-B** 配套筒

.材质/Material: 铁 iron  
.表面处理/Finish: 镀白锌+镀铬  
white zinc plated+chrome plated  
.备注/Remark:配锌合金套筒with zinc alloy sleeves

**ZD-J014**

.材质/Material: 铁 iron  
.表面处理/Finish: 黑色喷粉+镀铬  
Black powder+chrome plated  
.备注/Remark:配扁铁 with connecting plate

**ZD-J020** 配套筒

.材质/Material: 铁 iron  
.表面处理/Finish: 镀白锌+镀铬  
white zinc plated+chrome plated  
.备注/Remark:配锌合金套筒  
with zinc alloy sleeves



ZD-J系列



**ZD-J020 配螺杆**

.材质/Material: 铁 iron  
.表面处理/Finish: 镀白锌+镀铬  
white zinc plated+chrome plated  
.备注/Remark:配螺杆 with threaded rod



**ZD-J020-A配螺杆**

.材质/Material: 铁 iron  
.表面处理/Finish: 镀白锌+镀铬  
white zinc plated+chrome plated  
.备注/Remark:配螺杆 /配锌合金套筒 with threaded rod



**ZD-J020-A配套筒**

.材质/Material: 铁 iron  
.表面处理/Finish: 镀白锌+镀铬  
white zinc plated+chrome plated  
.备注/Remark:配锌合金套筒 Zinc alloy sleeve



**ZD-J022-A**

.材质/Material: 铁 iron  
.表面处理/Finish: 镀白锌+镀铬  
white zinc plated+chrome plated  
.备注/Remark:配锌合金套筒 with zinc alloy sleeve



**ZD-J023-A**

.材质/Material: 铁 iron  
.表面处理/Finish: 镀白锌+镀铬  
white zinc plated+chrome plated  
.备注/Remark:配螺杆 with threaded rod



**ZD-J023-B**

.材质/Material: 铁 iron  
.表面处理/Finish: 镀白锌+镀铬  
white zinc plated+chrome plated  
.备注/Remark:配82G合金套筒 with 82G alloy sleeve



ZD-J系列



**ZD-J025-A**

.材质/Material: 铁 iron  
.表面处理/Finish: 镀白锌+镀铬  
white zinc plated+chrome plated  
.备注/Remark:配螺杆 with threaded rod



**ZD-J025-B**

.材质/Material: 铁 iron  
.表面处理/Finish: 镀白锌+镀铬  
white zinc plated+chrome plated  
.备注/Remark:配82G合金套筒 with 82G alloy sleeve



**ZD-J027-B**

.材质/Material: 铁 iron  
.表面处理/Finish: 镀白锌white zinc plated  
.备注/Remark:配套筒 with alloy sleeves

ZD-L系列



**ZD-L001** 插片

.材质/Material: 铁 iron  
.表面处理/Finish: 镀彩锌/镀白锌  
color zinc plated /white zinc plated  
.厚度/Thickness: 1.5、1.8、2.0MM



**ZD-L003-F** 山字插片D

.材质/Material: 铁 iron  
.表面处理/Finish: 镀彩锌 color zinc plated  
.厚度/Thickness: 2.0MM



**ZD-L003-H**

.材质/Material: 铁 iron  
.表面处理/Finish: 镀彩锌 color zinc plated  
.厚度/Thickness: 1.8MM



**ZD-L002** 山字插片A

.材质/Material: 铁 iron  
.表面处理/Finish: 镀彩锌/镀白锌  
color zinc plated /white zinc plated  
.厚度/Thickness: 2.0MM



**ZD-L003** 山字插片B

.材质/Material: 铁 iron  
.表面处理/Finish: 镀彩锌/镀白锌  
color zinc plated /white zinc plated  
.厚度/Thickness: 2.0MM



**ZD-L003-J**

.材质/Material: 铁 iron  
.表面处理/Finish: 镀白锌 / white zinc plated  
.厚度/Thickness: 1.8MM



**ZD-L003-A** 山字插片C

.材质/Material: 铁 iron  
.表面处理/Finish: 镀彩锌/镀白锌  
color zinc plated /white zinc plated  
.厚度/Thickness: 2.0MM



**ZD-L003-B** 山字插片D

.材质/Material: 铁 iron  
.表面处理/Finish: 镀彩锌/镀白锌  
color zinc plated /white zinc plated  
.厚度/Thickness: 2.0MM



**ZD-L003-K**

.材质/Material: 铁 iron  
.表面处理/Finish: 镀白锌 / white zinc plated  
.厚度/Thickness: 2.0MM



**ZD-L003-W**

.材质/Material: 铁 iron  
.表面处理/Finish: 镀白锌 / white zinc plated  
.厚度/Thickness: 2.0MM



ZD-L系列



**ZD-L003-N**

.材质/Material: 铁 iron  
.表面处理/Finish: 镀白锌 white zinc plated



**ZD-L004**

.材质/Material: 铁 iron  
.表面处理/Finish: 镀白锌 white zinc plated



**ZD-L004-A**

.材质/Material: 铁 iron  
.表面处理/Finish: 镀白锌 white zinc plated



**ZD-L004-B**

.材质/Material: 铁 iron  
.表面处理/Finish: 镀白锌 white zinc plated  
.长度/Length: 160mm



**ZD-L004-C**

.材质/Material: 铁 iron  
.表面处理/Finish: 镀白锌 white zinc plated  
.长度/Length: 160mm

ZD-L系列



**ZD-L004-D**

.材质/Material: 铁 iron  
.表面处理/Finish: 镀白锌 white zinc plated  
.长度/Length: 220mm



**ZD-L005**

.材质/Material: 铁 iron  
.表面处理/Finish: 镀白锌 white zinc plated



**ZD-L006 V型插片**

.材质/Material: 铁 iron  
.表面处理/Finish: 镀白锌 white zinc plated  
.长度/Length: 120mm



**ZD-L006-A 长插片**

.材质/Material: 铁 iron  
.表面处理/Finish: 镀白锌、镀彩锌 white zinc plated / color zinc plated  
.长度/Length: 120, 160, 180mm

ZD-L系列



**ZD-L006-C**

.材质/Material: 铁 iron  
.表面处理/Finish: 镀白锌/ white zinc plated  
.长度/Length: 100、130、150、190mm  
.厚度/Thickness: 1.5、1.8mm



**ZD-L007**可調角碼

.材质/Material: 铁 iron  
.表面处理/Finish: 铁原色、鍍彩鋅 original color /color zinc plated  
.厚度/Thickness: 2.3mm



**ZD-L008**可調床腳

.材质/Material: 铁 iron  
.表面处理/Finish: 黑色、銀色、black、Silver  
.高度/height: 200mm



ZD-L系列



**ZD-L009**

.材质/Material: 铁 iron  
.表面处理/Finish: 黑色 black  
.厚度/Thickness: 1.8 & 2.0mm



**ZD-L009-A**

.材质/Material: 铁 iron  
.表面处理/Finish: 黑色 black  
.厚度/Thickness: 1.8 & 2.0mm



**ZD-L009-B**

.材质/Material: 铁 iron  
.表面处理/Finish: 黑色 black  
.厚度/Thickness: 1.8 mm



**ZD-L009-C**

.材质/Material: 铁 iron  
.表面处理/Finish: 黑色 black  
.厚度/Thickness: 2.5 mm



**ZD-L009-D**

.材质/Material: 铁 iron  
.表面处理/Finish: 黑色 black  
.厚度/Thickness: 1.5 mm



ZD-L系列



**ZD-L010**

.材质/Material: 铁 iron  
.规格/size: 36\*36\*105mm  
.厚度/Thickness: 2.0 mm  
.表面处理/Finish: 白色 white



**ZD-L012 (圆转盘)**

.材质/Material: 镀锌白 zinc plated  
.厚度/Thickness: 0.8mm  
.规格/size: 5.5、8、9、12寸 (inch)



**ZD-L016 (大圆转盘)**

.材质/Material: 铁 iron  
.表面处理/Finish: 黑色 black  
.圆径/Diameter: 600mm  
.规格/size: 10寸 (inch)

ZD-L系列



**ZD-L012 (方转盘)**

.材质/Material: 镀锌白 zinc plated  
.厚度/Thickness: 0.8mm  
.规格/size: 3、4、6寸 (inch)



**ZD-L014 (360度8寸转盘)**

.材质/Material: 铁 iron  
.表面处理/Finish: 黑色 black  
.厚度/Thickness: 1.8、2.0、2.3mm  
.规格/size: 150\*150、200\*200、250\*250、300\*300mm  
.钢珠/Ball Bearings: 全/半球 full/half ball bearings



**ZD-L017 (弹簧包)**

.高度/height: 80、100mm  
.弹簧线径/Spring diameter: 1.8、2.0mm  
.弹簧圈直径/Spring circle diameter: 60、65mm  
.弹簧个数/Number of springs: 7\*7=49



**ZD-L015 (回力转盘)**

.材质/Material: 铁 iron  
.表面处理/Finish: 黑色 black  
.厚度/Thickness: 2.3mm  
.规格/size: 160\*160、178\*178、200\*200mm



**ZD-L017-A (枕头包)**

.高度/height: 70-100mm  
.弹簧线径/Spring diameter: 1.0mm  
.弹簧圈直径/Spring circle diameter: 50mm  
.弹簧个数/Number of springs: 4\*10=40



**ZD-L018-A (拉手)**

.材质/Material: 201 不锈钢 (空心/实心)  
201 Stainless Steel (Hollow/solid)  
.厚度/Thickness: 0.5mm  
.规格/size: D12\*64\*L100、D12\*96\*L150、D12\*128\*L200、  
D12\*160\*L250、D12\*192\*L300、D12\*224\*L350mm  
.表面处理/Finish: 拉丝、黑色、金色 Brushed, black, gold

ZD-L系列



ZD-L018-C (拉手)

.材质/Material: 201 不锈钢 201 Stainless Steel  
.规格/size: D12\*64, D12\*76, D12\*96, D12\*128, D12\*160, D12\*192, D12\*224, D12\*256  
.表面处理/Finish: 拉丝, 黑色 Brushed, black



ZD-L018-D (拉手)

.材质/Material: 201 不锈钢 (空心/实心)  
201 Stainless Steel (Hollow/solid)  
.厚度/Thickness: 0.5mm  
.规格/size: D12\*64\*L100, D12\*96\*L150, D12\*128\*L200, D12\*160\*L250, D12\*192\*L300, D12\*224\*L350mm  
.表面处理/Finish: 拉丝, 黑色, 金色 Brushed, black, gold



ZD-L020-A (水晶球拉手)

.材质/Material: 玻璃 glass  
.规格/size: 20#, 25#, 30#, 40#



ZD-L020-D (拉手)

.材质/Material: 玻璃+锌合金 glass+zinc alloy  
.规格/size: D32\*H24mm



ZD-L020-E (拉手)

.材质/Material: 玻璃+锌合金 glass+zinc alloy  
.规格/size: D32\*H25mm



ZD-L020-F (拉手)

.材质/Material: Aluminium Alloy 铝合金  
.规格/size: D24\*H22mm



ZD-L020-B (包边拉手)

.材质/Material: 玻璃 glass  
.规格/size: 25#, 30#



ZD-L020-C (拉手)

.材质/Material: 玻璃 glass  
.规格/size: 20#, 25#, 30#



ZD-L020-G (拉手)

.材质/Material: Aluminium Alloy 铝合金  
.规格/size: D29\*H24mm



ZD-L020-H (拉手)

.材质/Material: Aluminium Alloy 铝合金  
.规格/size: D32\*H25mm



ZD-L系列



**ZD-L020-I** (拉手)

.材质/Material: Aluminium Alloy 铝合金  
.规格/size: D25\*H23mm



**ZD-L020-J** (拉手)

.材质/Material: Aluminium Alloy 铝合金  
.规格/size: 27\*31\*H21mm



**ZD-L021-B** (紫荆花钉帽)

.材质/Material: 玻璃 glass  
.规格/size: 20#, 22#, 25#, 30#



**ZD-L022-A** (卫星拉扣)

.材质/Material: 玻璃/亚克力 glass/acrylic  
.规格/size: 18#, 20#, 22#, 25#, 30#



**ZD-L020-K** (拉手)

.材质/Material: Aluminium Alloy 铝合金  
.规格/size: D33\*H35mm



**ZD-L020-L** (拉手)

.材质/Material: Aluminium Alloy 铝合金  
.规格/size: 24\*40\*H21mm



**ZD-L022-B** (卫星钉)

.材质/Material: 玻璃/亚克力 glass/acrylic  
.规格/size: 20#, 22#, 25#, 30#



**ZD-L022-C** (长叉)

.材质/Material: 玻璃/亚克力 glass/acrylic  
.规格/size: 20#, 22#, 25#, 30#



**ZD-L020-M** (拉手)

.材质/Material: Aluminium Alloy 铝合金  
.长度/length: 132mm  
.孔距/Hole Distance: 91mm



**ZD-L021-A** (紫荆花拉扣)

.材质/Material: 玻璃 glass  
.规格/size: 18#, 20#, 22#, 25#, 30#



**ZD-L023-A** (四格拉扣)

.材质/Material: 玻璃 glass  
.规格/size: 20#, 22#, 25#, 30#



**ZD-L023-B** (四格钉)

.材质/Material: 玻璃 glass  
.规格/size: 20#, 22#, 25#, 30#

ZD-L系列



ZD-L024-A 宝石花拉扣

.材质/Material: 玻璃 glass  
.规格/size: 20#, 22#, 25#, 30#



ZD-L024-B 宝石花钉

.材质/Material: 玻璃 glass  
.规格/size: 20#, 22#, 25#, 30#



ZD-L026-B (卫星亚克力穿线)

.材质/Material: 铁 iron  
.表面处理/Finish: 铁+亚克力 iron+acrylic  
.规格/size: 18#, 20#, 22#, 25#, 30#

ZD-L系列



ZD-L025-A (太阳花拉扣)

.材质/Material: 玻璃 glass  
.规格/size: 20#, 22#, 25#, 30#



ZD-L025-B (太阳花钉)

.材质/Material: 玻璃 glass  
.规格/size: 20#, 22#, 25#, 30#



ZD-L026-C (卫星包边圆点)

.材质/Material: 铁 iron  
.表面处理/Finish: 铁+亚克力 iron+acrylic  
.规格/size: 20#, 25#



ZD-L027 包布钉

.材质/Material: 铁 iron  
.表面处理/Finish: 镀白锌 white zinc plated  
.规格/size: 28#, 30#, 36#



ZD-L026 (倒角包布钉)

.材质/Material: 亚克力 acrylic  
.规格/size: 22#



ZD-L026-A (卫星亚克力穿线)

.材质/Material: 铁 iron  
.表面处理/Finish: 亚克力 acrylic  
.规格/size: 16#, 18#, 20#, 22#, 25#, 28#, 30#



ZD-L027-A 包布纽扣

.材质/Material: 铁 iron  
.表面处理/Finish: 镀白锌 white zinc plated  
.规格/size: 28#, 30#, 36#, 40#



ZD-L027-B

.材质/Material: 锌合金 Zinc alloy  
.表面处理/Finish: 金色、银色、红古、青色、gold、silver, red copper, bronze  
.规格/size: 50\*10\*T2.0mm



ZD-L系列



**ZD-L027-B2**

.材质/Material: 锌合金 Zinc alloy  
.表面处理/Finish: 金色、银色、gold、silver  
.规格/size: 50\*10\*T1.0mm



**ZD-L027-B3**

.材质/Material: 铁 iron  
.表面处理/Finish: 金色 Gold  
.长度/length: 40、50、100、150、200、250、300、350  
400、450、450、500、550、600、650、700、800mm



**ZD-L027-B6-B (圆拉扣)**

.材质/Material: 锌合金 zinc alloy  
.表面处理/Finish: 金色、银色 gold、silver  
.尺寸/size: L96\*W99mm



**ZD-L027-B5 (狮子头拉扣)**

.材质/Material: 锌合金 zinc alloy  
.表面处理/Finish: 金色、银色 gold、silver  
.规格/size: W116\*L130mm



**ZD-L027-B7 (四方扣)**

.材质/Material: 锌合金 zinc alloy  
.表面处理/Finish: 金色、银色 gold、silver  
.尺寸/size: 25\*25\*T1.5 mm



**ZD-L027-B8**

.材质/Material: 锌合金 zinc alloy  
.规格/size: W114\*H122M



**ZD-L027-B6 (圆拉扣)**

.材质/Material: 锌合金 zinc alloy  
.表面处理/Finish: 金色、银色 gold、silver  
.尺寸/size: 54\*31mm  
.内直径/internal diameter: 61、78mm  
.外直径/External diameter: 79、97mm



**ZD-L027-B6-A (圆拉扣)**

.材质/Material: 锌合金 zinc alloy  
.表面处理/Finish: 金色、银色 gold、silver  
.尺寸/size: 55\*38mm  
.内直径/internal diameter: 72mm  
.外直径/External diameter: 98mm



**ZD-L027-B9 (六边平扣)**

.材质/Material: 锌合金 zinc alloy  
.表面处理/Finish: 金色、银色 gold、silver  
.尺寸/size: 25\*25\*T1.5 mm



**ZD-L027-B10 (圆形平扣)**

.材质/Material: 锌合金 zinc alloy  
.表面处理/Finish: 银色、金色 silver、gold  
.规格/size: 25\*25\*T1.8mm

ZD-L系列



ZD-L027-B11

.材质/Material: 锌合金 zinc alloy  
.表面处理/Finish: 枪黑、金色 gun black, gold  
.规格/size: 40\*10、60\*10mm



ZD-L027-B12

.材质/Material: 锌合金 zinc alloy  
.表面处理/Finish: 枪黑、金色、玫瑰金 Gun black, gold, Rose Gold  
.规格/size: 50\*10\*T3.0mm



ZD-L027-B17

.材质/Material: 锌合金 zinc alloy  
.表面处理/Finish: 枪黑、金 Gun Black, gold  
.规格/size: 45\*10mm

ZD-L系列



ZD-L027-B18

.材质/Material: 锌合金 zinc alloy  
.表面处理/Finish: 玫瑰金 Rose Gold



ZD-L027-B13

.材质/Material: 锌合金 zinc alloy  
.表面处理/Finish: 枪黑、金色、银色, gun black gold, silver,



ZD-L027-B14

.材质/Material: 锌合金 zinc alloy  
.表面处理/Finish: 枪黑、金色、银色 Gun black, gold, silver  
.规格/size: 41\*12mm



ZD-L027-B19

.材质/Material: 锌合金 zinc alloy  
.表面处理/Finish: 金 gold  
.外直径/External diameter: 55、70mm



ZD-L027-B15

.材质/Material: 锌合金 zinc alloy  
.表面处理/Finish: 枪黑配金 Gun Black with gold  
.规格/size: 65\*10mm



ZD-L027-B16

.材质/Material: 锌合金 zinc alloy  
.表面处理/Finish: 枪黑配金 Gun Black with gold  
.规格/size: 45\*15mm



ZD-L027-B20

.材质/Material: 锌合金 zinc alloy  
.表面处理/Finish: 玫瑰金 Rose Gold



ZD-L系列

ZD-L系列



**ZD-L027-B21**

.材质/Material: 锌合金 zinc alloy  
.表面处理/Finish: 枪黑、金 Gun Black、gold



**ZD-L027-B22**

.材质/Material: 锌合金 zinc alloy  
.表面处理/Finish: 枪黑、金、玫瑰金 Gun Black、gold、Rose Gold



**ZD-L027-B26**

.材质/Material: 锌合金 zinc alloy  
.表面处理/Finish: 黑、金色 Black、gold  
.规格/size: 51\*34mm



**ZD-L027-B23**

.材质/Material: 锌合金 zinc alloy  
.表面处理/Finish: 金色、银色 gold、silver



**ZD-L027-B24**

.材质/Material: 锌合金 zinc alloy  
.表面处理/Finish: 枪黑 Gun Black  
.长度/length: 90mm



**ZD-L027-B27**

.材质/Material: 锌合金 zinc alloy  
.表面处理/Finish: 金色 gold  
.长度/length: 51\*34mm  
.规格/size: 30\*105mm



**ZD-L027-B28**

.材质/Material: 锌合金 zinc alloy  
.表面处理/Finish: 金色、银色 gold、Silver  
.外直径/External diameter: 45、60 mm



**ZD-L027-B25**

.材质/Material: 锌合金 zinc alloy  
.表面处理/Finish: 金色、银色 gold、silver  
.规格/size: W70\*L115mm



**ZD-L027-B29**

.材质/Material: 锌合金 zinc alloy  
.表面处理/Finish: 黑色、金色、镀铬 black、gold、chrome plated



**ZD-L027-B30**

.材质/Material: 锌合金 zinc alloy  
.表面处理/Finish: 黑色、金色、镀铬、玫瑰金 black、gold、chrome plated、Rose Gold  
.规格/size: 65\*70mm

ZD-L系列



ZD-L027-B31

.材质/Material: 锌合金 zinc alloy  
.表面处理/Finish: 黑色、金色、镀铬、玫瑰金 black, gold, chrome plated, Rose Gold  
.规格/size: 55\*75mm



ZD-L027-B32

.材质/Material: 锌合金 zinc alloy  
.表面处理/Finish: 金色、镀铬、gold, chrome plated,  
.规格/size: 40\*45mm



ZD-L027-B37

.材质/Material: 锌合金 zinc alloy  
.表面处理/Finish: 黑色、金色、镀铬、玫瑰金 black, gold, chrome plated, Rose Gold  
.规格/size: 60\*70、70\*80mm



ZD-L027-B38

.材质/Material: 锌合金 zinc alloy  
.表面处理/Finish: 黑色、金色、镀铬、玫瑰金 black, gold, chrome plated, Rose Gold  
.规格/size: 55\*60mm



ZD-L027-B33

.材质/Material: 锌合金 zinc alloy  
.表面处理/Finish: 金色 gold  
.规格/size: 50\*55mm



ZD-L027-B34

.材质/Material: 锌合金 zinc alloy  
.表面处理/Finish: 金色 gold  
.规格/size: 50\*52mm



ZD-L027-C

.材质/Material: 铁 iron  
.表面处理/Finish: 黑色、金色、镀铬、玫瑰金 black, gold, chrome plated, Rose Gold  
.规格/size: 60\*12\*T2.0mm



ZD-L027-D

.材质/Material: 铁 iron  
.表面处理/Finish: 金色 gold  
.规格/size: 55\*12\*T2.0mm



ZD-L027-B35

.材质/Material: 锌合金 zinc alloy  
.表面处理/Finish: 黑色、金色、镀铬、玫瑰金 black, gold, chrome plated, Rose Gold  
.规格/size: 35\*80、35\*115 mm



ZD-L027-B36

.材质/Material: 锌合金 zinc alloy  
.表面处理/Finish: 金色、镀铬 gold, chrome plated  
.规格/size: 40\*123mm



ZD-L027-F1 (实心)

.材质/Material: 锌合金 zinc alloy  
.表面处理/Finish: 银色、金色 Silver, gold  
.规格/size: 45\*10\*T4.0mm



ZD-L系列



**ZD-L027-F2 (空心)**

.材质/Material: 锌合金 zinc alloy  
.表面处理/Finish: 银色、金色 Silver, gold  
.规格/size: 45\*10\*T4.0mm



**ZD-L027-G1**

.材质/Material: 锌合金 zinc alloy  
.表面处理/Finish: 玫瑰金 Rose gold  
.规格/size: 50\*9\*T5.0mm



ZD-L系列



**ZD-L027-J 带环塑料件**

.材质/Material: 塑料 Plastics  
.表面处理/Finish: 镀铬、金色 chrome plated, gold  
.规格/size: 300\*120mm



**ZD-L027-G2 (空心)**

.材质/Material: 锌合金 zinc alloy  
.规格/size: 50\*9\*T5.0mm



**ZD-L027-H**

.材质/Material: 锌合金 zinc alloy  
.表面处理/Finish: 银色、金色 Silver, gold  
.规格/size: 38\*17\*2.5mm



**ZD-L027-K 带环塑料件**

.材质/Material: 塑料 Plastics  
.表面处理/Finish: 镀铬、金色 chrome plated, gold  
.规格/size: 250\*140mm



**ZD-L028-A 0.8五孔弹簧夹**

**ZD-L028-B 1.0五孔弹簧夹**

.材质/Material: 铁 Iron  
.厚度/Thickness: 0.8、1.0mm  
.孔数/Hole Quantity: 5孔 (Holes)



**ZD-L027-I 带环塑料件**

.材质/Material: 塑料 Plastics  
.表面处理/Finish: 镀铬、金色 chrome plated, gold  
.规格/size: 300mm\*60mm



**ZD-L028-C 1.0四孔弹簧夹**

**ZD-L028-D 1.0四孔加长弹簧夹**

.材质/Material: 铁 iron  
.厚度/Thickness: 1.0mm  
.孔数/Hole Quantity: 4孔 (Holes)



ZD-L系列



ZD-L030

.材质/Material: 铁 iron  
.表面处理/Finish: 镀彩锌 Color zinc plated



ZD-L031

.材质/Material: 铁 iron  
.表面处理/Finish: 镀彩锌 Color zinc plated



ZD-L033-C

.材质/Material: 铁 iron  
.表面处理/Finish: 镀彩锌 Color zinc plated  
.规格/size: 38\*20\*T1.2mm

ZD-L系列



ZD-L033-D

.材质/Material: 铁 iron  
.表面处理/Finish: 镀彩锌 Color zinc plated  
.规格/size: 45\*30\*T1.2mm



ZD-L032

.材质/Material: 铁 iron  
.规格/size: 60\*60, 70\*70, 80\*80,  
90\*90, 100\*100mm  
.厚度/Thickness: 1.2, 1.5, 2.0 mm



ZD-L033-A

.材质/Material: 铁 iron  
.表面处理/Finish: 镀彩锌 Color zinc plated  
.规格/size: 20\*25\*T1.0mm



ZD-L033-E

.材质/Material: 铁 iron  
.表面处理/Finish: 镀彩锌 Color zinc plated  
.规格/size: 30\*32\*T1.8mm



ZD-L033-E1

.材质/Material: 铁 iron  
.表面处理/Finish: 白锌 white zinc  
.规格/size: 40\*50\*T2.0mm



ZD-L033-B

.材质/Material: 铁 iron  
.表面处理/Finish: 镀彩锌 Color zinc plated  
.规格/size: 24\*25\*T1.5mm

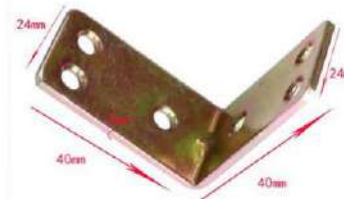

ZD-L033-F

.材质/Material: 铁 iron  
.表面处理/Finish: 镀彩锌 Color zinc plated  
.规格/size: 40\*24\*T2.0 mm



ZD-L033-I

.材质/Material: 铁 iron  
.表面处理/Finish: 镀彩锌 Color zinc plated



ZD-L系列



ZD-L033-J

.材质/Material: 铁 iron  
.表面处理/Finish: 镀彩锌 Color zinc plated



ZD-L033-K

.材质/Material: 铁 iron  
.表面处理/Finish: 黑色 black  
.规格/size: 50\*90\*T2.5mm



ZD-L036

.材质/Material: 铁 iron  
.表面处理/Finish: 镀彩锌 Color zinc plated



ZD-L037

.材质/Material: 铁 iron  
.厚度/Thickness: 0.5mm  
.总长度/Total length: 20m



ZD-L033-L

.材质/Material: 铁 iron  
.表面处理/Finish: 镀彩锌 Color zinc plated  
.规格/size: 67\*90\*T1.8 mm



ZD-L033-N-M

.材质/Material: 铁 iron  
.表面处理/Finish: 镀彩锌 Color zinc plated  
.规格/size: 50\*80mm  
.厚度/Thickness: 1.5, 1.8 mm



ZD-L038

.材质/Material: 塑料+铁 Plastic iron  
.总长/Total length: 1m



ZD-L039

.材质/Material: 铁 iron



ZD-L033-O

.材质/Material: 塑料+铁 Plastic iron  
.表面处理/Finish: 镀彩锌 Color zinc plated  
.规格/size: 60\*90\*T1.8 mm



ZD-L033-P

.材质/Material: 铁 iron  
.表面处理/Finish: 镀彩锌 Color zinc plated



ZD-L040

.材质/Material: 纸包线 Paper covered wire  
.规格/size: 500米/卷 500m/roll



ZD-L系列



**ZD-L101猫眼条**

.材质/Material: 铁 iron  
.规格/size: 9.5\*1000, 11\*1000, 16\*1000mm  
.尺寸可订做: Size can be customized



**ZD-L102花条**

.材质/Material: 铁 iron  
.规格/size: 11\*1000mm  
.颜色/color: 金、银、青古、红古 gold, Silver, Bronze, red copper  
.尺寸可订做: Size can be customized



**ZD-L107光面条**

.材质/Material: 铁 iron  
.规格/size: 9.5\*1000, 11\*1000, 16\*1000mm  
.颜色/color: 金、银、青古、红古 gold, Silver, Bronze, red copper  
.尺寸可订做: Size can be customized

ZD-L系列



**ZD-L113正方光钉**

.材质/Material: 铁 iron  
.规格/size: #12, #19mm  
.颜色/color: 银、青古 Silver, Bronze  
.尺寸可订做: Size can be customized



**ZD-L115猫眼钉**

.材质/Material: 铁 iron  
.规格/size: 9.5\*17, 11\*17, 12\*17, 16\*20mm  
.颜色/color: 青古色 Bronze



**ZD-L117花钉**

.材质/Material: 铁 iron  
.规格/size: 11\*17mm  
.颜色/color: 金、银、青古、红古 gold, Silver, Bronze, red copper



**ZD-L118光面钉**

.材质/Material: 铁 iron  
.规格/size: 8\*17, 9.5\*17, 11.3\*17, 16\*20, 19\*23, 21\*23, 25\*25, 30\*28mm  
.颜色/color: 金、银、青古、红古 gold, Silver, Bronze, red copper





ZD-L系列



ZD-L201

.材质/Material:铝合金 Aluminium alloy  
.规格/Size:L 96\*L119、128\*150、160\*184mm  
.表面处理/Finish :哑黑色、哑光白、哑金、银黑色  
Matte black, Matte White, Matte gold, Silver black



ZD-L205

.材质/Material:铝合金 Aluminium alloy  
.规格/Size:L 64\*L190、96\*120、128\*150、160\*190mm  
.表面处理/Finish :哑黑色、哑光白、哑金、  
Matte black, Matte White, Matte gold



ZD-L206

.材质/Material:铝合金 Aluminium alloy  
.规格/Size:L 64\*L60、96\*120、128\*150、160\*190mm  
.表面处理/Finish :哑黑色、哑光白、哑金、Matte black  
、Matte White、Matte gold



ZD-L202

.材质/Material:铝合金 Aluminium alloy  
.规格/Size:L 96\*L119、128\*150、160\*184mm  
.表面处理/Finish :哑黑色、哑光白、哑金、银黑色  
Matte black, Matte White, Matte gold, Silver black



ZD-L203

.材质/Material:铝合金 Aluminium alloy  
.规格/Size:L 32\*L40、64\*72、96\*104mm  
.表面处理/Finish :哑黑色、哑光白、哑金、  
Matte black, Matte White, Matte gold



ZD-L207

.材质/Material:铝合金 Aluminium alloy  
.规格/Size:L 64\*L90、96\*120、128\*150、160\*190mm  
.表面处理/Finish :哑黑色、哑光白、哑金、Matte black、  
Matte White, Matte gold



ZD-L208

.材质/Material:铝合金 Aluminium alloy  
.规格/Size:L96\*L120、128\*150、160\*183mm  
.表面处理/Finish :哑黑色、哑光白、哑金、银黑色  
Matte black, Matte White, Matte gold, Silver black



ZD-L204

.材质/Material:铝合金 Aluminium alloy  
.规格/Size:L 96\*L162、128\*195、160\*228mm  
.表面处理/Finish :哑黑色、哑光白、哑金、银黑色  
Matte black, Matte White, Matte gold, Silver black



ZD-L209

.材质/Material:铝合金 Aluminium alloy  
.规格/Size:L64\*L90、96\*120、128\*150、160\*190mm  
.表面处理/Finish :哑黑色、哑光白、哑金、银黑色  
Matte black, Matte White, Matte gold, Silver black



ZD-L210

.材质/Material:铝合金 Aluminium alloy  
.规格/Size:L96\*120、128\*152、160\*185mm  
.表面处理/Finish :哑黑色、哑光白、哑金、银黑色  
Matte black, Matte White, Matte gold, Silver black

ZD-L系列



ZD-L211

.材质/Material:铝合金 Aluminium alloy  
.规格/Size:L 64\*L84、96\*L116、160\*L180mm  
.表面处理/Finish :哑黑色、哑光白 Matte black、Matte White



ZD-L212

.材质/Material:铝合金 Aluminium alloy  
.规格/Size:L 64\*L84、96\*L116、128\*L148、160\*L180mm  
.表面处理/Finish :哑黑色、哑光白 Matte black、Matte White



ZD-L213

.材质/Material:铝合金 Aluminium alloy  
.规格/Size:L 96\*L142、160\*206、256\*302mm  
.表面处理/Finish :云雾黑+高亮银、云雾黑+青铜金 Cloudy balckHighlight silver, Cloudy balck+Bronze gold



ZD-L214

.材质/Material:铝合金 Aluminium alloy  
.规格/Size:L 128\*L146、192\*210、288\*306mm  
.表面处理/Finish :云雾黑+高亮银、云雾黑+青铜金 Cloudy balckHighlight silver, Cloudy balck+Bronze gold



ZD-L215

.材质/Material:铝合金 Aluminium alloy  
.规格/Size:L 128\*L146、192\*210、288\*306mm  
.表面处理/Finish :云雾黑+高亮银、云雾黑+青铜金 Cloudy balckHighlight silver, Cloudy balck+Bronze gold



ZD-L216

.材质/Material:铝合金 Aluminium alloy  
.规格/Size:L 32\*L42、96\*L118、160\*L182mm  
.表面处理/Finish :云雾黑+高亮银、云雾黑+青铜金 Cloudy balckHighlight silver, Cloudy balck+Bronze gold



ZD-L218

.材质/Material:铝合金 Aluminium alloy  
.规格/Size:L96\*L158、128\*190、160\*286mm  
.表面处理/Finish :云雾黑+高亮银、云雾黑+青铜金 Cloudy balckHighlight silver, Cloudy balck+Bronze gold



ZD-L220

.材质/Material:铝合金 Aluminium alloy  
.规格/Size:L64\*L86、96\*L118、128\*150、160\*182、224\*246mm  
.表面处理/Finish :云雾黑+高亮银、云雾黑+青铜金 Cloudy balckHighlight silver, Cloudy balck+Bronze gold

ZD-L系列

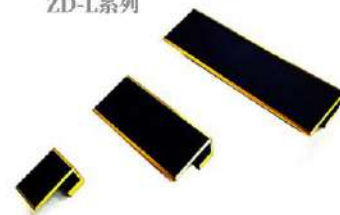

ZD-L217

.材质/Material:铝合金 Aluminium alloy  
.规格/Size:L 28\*39、96\*L118、160\*L182mm  
.表面处理/Finish :云雾黑+高亮银、云雾黑+青铜金 Cloudy balckHighlight silver, Cloudy balck+Bronze gold



ZD-L219

.材质/Material:铝合金 Aluminium alloy  
.规格/Size:L28\*L37、96\*L118、160\*L182mm  
.表面处理/Finish :云雾黑+高亮银、云雾黑+青铜金 Cloudy balckHighlight silver, Cloudy balck+Bronze gold



ZD-L221

.材质/Material:铝合金 Aluminium alloy  
.规格/Size:96\*L150、128\*192、160\*224mm  
.表面处理/Finish :拉丝金、拉丝银 Gold、Silver



ZD-MX系列



**ZD-MX03** (普通电机双人座/三人座/Double seats/  
Three seats)

.规格size:铁架宽/Iron frame width:490mm  
.双人座/三人座带电机: Double seats/Three seats  
Installation motor  
.材质/Material: Iron(铁)  
.表面处理/Finish:喷粉黑 Powder Coating Black



**ZD-MX03-C**

.长度/Length:1050mm  
.厚度/Thickness:4.0mm  
.材质/Material: Iron(铁)  
.表面处理/Finish:喷粉黑 Powder Coating Black



**ZD-MX03-C1**

.长度/Length:850mm  
.厚度/Thickness:4.0mm  
.材质/Material: Iron(铁)  
.表面处理/Finish:喷粉黑 Powder Coating Black



**ZD-MX03** (电机 单座/one seat)

.规格size:铁架宽/Iron frame width:490mm  
.厚度/Thickness:2.5&3.5&4.0mm  
.单人座带电机: one seat Installation motor  
.材质/Material: Iron(铁)  
.表面处理/Finish:喷粉黑 Powder Coating Black



**ZD-MX03-A** (单人座/one-seat)  
普通手动铁架, 没有翻转功能

.规格size:铁架宽/Iron frame width:490mm  
.厚度/Thickness:2.5&3.5&4.0mm  
.单人座: one seat  
.材质/Material: Iron(铁)  
.表面处理/Finish:喷粉黑 Powder Coating Black



**ZD-MX03-D** (单人座/one-seat)  
手动摇带转铁架

.规格size:铁架宽/Iron frame width:490mm  
.厚度/Thickness:2.5&3.5&4.0mm  
.单人座手动 摇带转: One seat Manual belt rolling  
.材质/Material: Iron(铁)  
.表面处理/Finish:喷粉黑 Powder Coating Black



**ZD-MX03-E** (单人座/one-seat)

.规格size:铁架宽/Iron frame width:490mm  
.厚度/Thickness:2.5&3.5&4.0mm  
.单人座安装电机: one seat Installation motor  
.材质/Material: Iron(铁)  
.表面处理/Finish:喷粉黑 Powder Coating Black

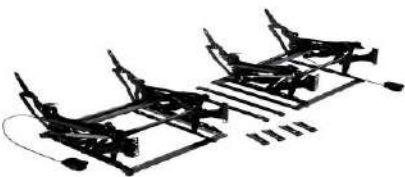

**ZD-MX03-A** (双人座/三人座Double seats/Three seats)  
手动功能铁架 双位/三位 分体角铁

.规格size:铁架宽/Iron frame width:490mm  
.厚度/Thickness:2.5&3.5&4.0mm  
.双人座/三人座: Double seats/Three seats  
.材质/Material: Iron(铁)  
.表面处理/Finish:喷粉黑 Powder Coating Black



**ZD-MX03-B** (单人座/one-seat)

.规格size:铁架宽/Iron frame width:495mm  
.厚度/Thickness:2.5&3.5&4.0mm  
.单人座 电动 摇带转: one seat Eccric belt swing iron Frame  
.材质/Material: Iron(铁)  
.表面处理/Finish:喷粉黑 Powder Coating Black



**ZD-MX03-F**

.规格size:铁架宽/Iron frame width:610mm  
.双电动机带头枕: Double motor  
.材质/Material: Iron(铁)  
.表面处理/Finish:喷粉黑 Powder Coating Black



**ZD-MX03-H** (普通手动前后摇铁架)

.规格size:铁架宽/Iron frame width:495mm  
.材质/Material: Iron(铁)  
.单人座 前后摇动: one seat shake black and forth  
.表面处理/Finish:喷粉黑 Powder Coating Black

ZD-MX系列



ZD-MX03-I

.材质/Material: Iron(铁)  
.单人座手动摇带转: One seat Mauul belt rolling  
.表面处理/Finish: 喷粉黑 Powder Coating Black



ZD-MX04 304不锈钢杯

.材质/Material: 304 stainless steel (304不锈钢)  
.表面处理/Finish: 亮光、拉丝 Polish chrome、Brushed  
.规格/size: 107\*85\*H35、79\*66\*H45、107\*85\*H55、86\*73\*H56、107\*86\*H58、105\*85\*H88 mm



ZD-MX05-B(塑料)

.材质/Material: Plastic (塑料)  
.表面处理/Finish: 黑色 black

ZD-MX系列



ZD-MX04-A 201不锈钢杯

.材质/Material: 201 stainless steel (201不锈钢)  
.表面处理/Finish: 亮光、拉丝 Polish chrome、Brushed  
.规格/size: 80\*68\*25、107\*85\*35、110\*90\*38、115\*95\*40、94\*82\*57、107\*85\*55、110\*90\*57、102\*90\*60mm



ZD-MX04-B

.材质/Material: 201 stainless steel (201不锈钢)  
.表面处理/Finish: 拉丝 Brushed



ZD-MX06

.材质/Material: Iron、Wood (铁+木)  
.规格/size: 1.94M\*1.4M  
.表面处理/Finish: 黑色 black  
.备注/Remark: 尺寸可以订做 Sizes can be customized



ZD-MX07

.材质/Material: Iron+Wood (铁+木)  
.规格/size: 1.94M\*1.4M  
.表面处理/Finish: 木 Wood  
.备注/Remark: 尺寸可以订做 Sizes can be customized



ZD-MX05铝杯

.材质/Material: Aluminium (铝)  
.表面处理/Finish: 亮光、金色、玫瑰金、黑色  
Polish chrome、gold、rose gold、black  
.规格/size: 102\*80\*133、110\*88\*65、102\*80\*65mm



ZD-MX05-A(夜光杯)

.材质/Material: Aluminium (铝)  
.表面处理/Finish: 黑色、哑白色、玫瑰金 back、rose gold、matte white  
.规格/size: 120\*89\*65mm





ZD-MX系列



ZD-MX08

- .材质/Material: Iron+Leather(铁+皮)
- .规格/size: 1.94M\*0.9M, 1.94M\*1.0M, 1.94M\*1.2M, 1.94M\*1.5M
- .表面处理/Finish: 黑色 black
- .备注/Remark: 尺寸可以订做 Sizes can be customized



ZD-T001

- .材质/Material: Iron 铁
- .角码/Corner connection: 97\*79\*34mm
- .铁片/Iron: 105\*50mm
- .厚度/Thickness: 2.0mm
- .表面处理/Finish: 白锌 white Zinc



ZD-T005

- .材质/Material: Iron 铁
- .表面处理/Finish: 黑色、白色 Black, white
- .规格/size: 8inch, 10inch, 12 inch, 14inch, 16inch, 20inch

ZD-T系列



ZD-T006-A(手动升降调高桌)

- .材质/Material: Aluminum(铝)
- .表面处理/Finish: 哑白色 Matte White
- .推荐桌面/Recommended desktop: 75\*75cm
- .升起承重/Raise the load-bearing ≤60kg,
- .降下承重/Put it down Load bearing ≤800kg



ZD-T001-A

- .材质/Material: Iron 铁
- .厚度/Thickness: 1.8mm
- .表面处理/Finish: 白锌 white Zinc



ZD-T002

- .材质/Material: EPE(珍珠棉)
- .规格/size: L102\*L100\*T1.2、L110\*L102\*T1.2MM
- .高度/Height: 82、110MM
- .表面处理/Finish: 蓝色 blue



ZD-T006-B(手动升降调高桌)

- .材质/Material: Aluminum(铝)
- .表面处理/Finish: 哑白色 Matte White
- .推荐桌面/Recommended desktop: ≤90\*90cm
- .升起承重/Raise the load-bearing ≤70kg,
- .降下承重/Put it down Load bearing ≤1000kg



ZD-T007(电动升降调高桌)

- .材质/Material: Aluminum(铝)
- .表面处理/Finish: 哑白色 Matte White
- .升起承重/Raise the load-bearing ≤140kg,
- .降下承重/Put it down Load bearing ≤2000kg
- .电压/ Voltage : 220v



ZD-T003

- .材质/Material: EPE(珍珠棉)
- .规格/size: L 330\*W 120\*H50MM
- .厚实/thickness: 5.5mm
- .表面处理/Finish: 蓝色 blue



ZD-T004

- .材质/Material: EPE(珍珠棉)
- .规格/size: L160\*W 55\*H40MM
- .厚实/thickness: 5.5mm
- .表面处理/Finish: 蓝色 blue



ZD-T008(电动升降调高桌)

- .材质/Material: Aluminum(铝)
- .表面处理/Finish: 哑白色 Matte White
- .推荐桌面/Recommended desktop: ≤100\*100cm
- .升起承重/Raise the load-bearing ≤80kg,
- .降下承重/Put it down Load bearing ≤1200kg
- .电压/ Voltage : 24v



ZD-T009(气动升降调高桌)

- .材质/Material: Aluminum(铝)
- .表面处理/Finish: 黑色 Black
- .升起承重/Raise the load-bearing ≤80kg,
- .降下承重/Put it down Load bearing ≤1200kg

ZD-MF系列



**ZD-MF01** Slat Bed Frame(排骨架)两排

.材质/Material: Iron+wood 铁+木  
.表面处理/Finish:黑色、白色 Black, white  
.规格/size: 1500\*2000MM  
.喷涂方式/Spray method: 烤漆 Paint baking  
.包装尺寸/packing size:1500\*2000\*45MM



**ZD-MF01** Slat Bed Frame(排骨架)三排

.材质/Material: Iron+wood 铁+木  
.表面处理/Finish:黑色、白色 Black, White  
.规格/size: 1800\*2000MM  
.喷涂方式/Spray method: 烤漆 Paint baking  
.包装尺寸/packing size: 1800\*2000\*45MM



**ZD-MF02** Enhance Slat Bed Frame(加强型排骨架)

.材质/Material: Iron+wood 铁+木  
.表面处理/Finish:黑色、白色 Black, white  
.规格/size: 1800\*2000MM  
.喷涂方式/Spray method: 烤漆 Paint baking  
.包装尺寸/packing size:1800\*2000\*45MM



**ZD-MF03** Fold Slat Bed Frame(折叠排骨架)

.材质/Material: Iron+wood 铁+木  
.表面处理/Finish:黑色、白色 Black, White  
.规格/size: 1500\*2000、1800\*2000 MM  
.喷涂方式/Spray method: 烤漆 Paint baking



**ZD-MF05** Fold Slat Bed Frame  
(折叠排骨架)

.材质/Material: Iron+wood 铁+木  
.表面处理/Finish:黑色、白色 Black, White  
.规格/size: 1500\*2000、1800\*2000 MM  
.喷涂方式/Spray method: 烤漆、粉末喷涂 Paint baking、  
powder Coating



**ZD-MF06**

.材质/Material: Iron+Solid Wood 铁+实木  
.表面处理/Finish:黑色、白色 Black, White  
.规格/size: 1000\*2000、1800\*2000 MM  
.尺寸可订做: Size can be customized

ZD-MF系列



五金配件



**ZD-MF07** Combination Slat Bed Frame  
(拆装型排骨架)

.材质/Material: Iron+wood 铁+木  
.表面处理/Finish:黑色、白色 Black, White  
.规格/size: 1600\*2000 MM  
.喷涂方式/Spray method: 烤漆 Paint baking  
.包装尺寸/packing size: 1600\*100\*100MM





ZD-W系列



**ZD-W001-A** 手动款壁床配件

.材质/Material: Iron+wood 铁+木  
.表面处理/Finish:黑色、白色 Black、White  
.规格/size: W1210\*L2010MM  
尺寸可订做: Size can be customized



ZD-W系列



**ZD-W002-A** 电动款壁床配件

.材质/Material: Iron+wood 铁+木  
.表面处理/Finish:黑色、白色 Black、White  
.规格/size: W1210\*L2010MM  
尺寸可订做: Size can be customized



ZD-P系列



**ZD-P001固定轮**

.材质/Material: 塑料 PVC  
.规格/size: 1寸、1.25寸、1.5寸、2寸、2.5寸、3寸  
1 INCH、1.25INCH、2INCH、2.5INCH、3INCH  
.颜色/colour: 白色 White



**ZD-P002万向轮**

.材质/Material: 塑料、橡胶 PVC、Rubber  
.规格/size: 1.25寸、1.5寸、2寸、2.5寸、3寸  
1.25 INCH、2 INCH、2.5 INCH、3 INCH  
.颜色/colour: 白色 White



**ZD-P006-A无刹车**

.材质/Material: 锌合金 Zinc alloy  
.规格/Size: 1.5寸 2寸 1.5INCH, 2NCH  
.颜色/Colour: 黑色 Black  
.高度/height: 60mm, 70mm



**ZD-P007 带刹车**

.材质/Material: 锌合金 Zinc alloy  
.规格/Size: 1.5寸 2寸 1.5INCH, 2NCH  
.颜色/Colour: 黑色 Black  
.高度/height: 70mm, 80mm



**ZD-P003平底边刹车**

.材质/Material: 塑料、橡胶 PVC、Rubber  
.规格/Size: 1.5寸、2寸、2.5寸、3寸  
1.5 INCH、2 INCH、2.5 INCH、3 INCH  
.颜色/Colour: 白色、黑色 White、Black



**ZD-P005**

.材质/Material: 塑料、橡胶 PVC、Rubber  
.规格/size: 1.5寸、2寸、1.5 INCH、2 INCH  
.颜色/colour: 黑色 Black



**ZD-P007-A**

.材质/Material: 锌合金 Zinc alloy  
.规格/Size: 1.5寸 2寸 1.5INCH, 2NCH  
.颜色/Colour: 黑色 Black  
.高度/height: 70mm, 80mm



**ZD-P008**

.材质/Material: 塑料、橡胶 PVC、Rubber  
.规格/size: 1寸、1.5寸、2寸、1INCH、1.5INCH、2 INCH  
.颜色/colour: 黑色 black  
.高度/height: 41、53、63mm



**ZD-P006带刹车**

.材质/Material: 锌合金 Zinc alloy  
.规格/Size: 1.5寸 2寸 1.5INCH, 2NCH  
.颜色/Colour: 黑色 Black  
.高度/height: 60mm, 70mm



**ZD-P008-A**

.材质/Material: 塑料、橡胶 PVC、Rubber  
.规格/size: 1寸、1.5寸、2寸、1INCH、1.5INCH、2 INCH  
.颜色/colour: 黑色 black  
.高度/height: 41、53、63mm





ZD-P系列



**ZD-P009带刹车**

.材质/Material: 尼龙 nylon  
.规格 size: 1寸、1.5寸、2寸 1INCH、1.5 INCH、2INCH、  
.颜色/Colour: 黑色: black  
.高度/height: 53、63、83mm



**ZD-P009-A无刹车**

.材质/Material: 尼龙 nylon  
.规格 size: 1寸、1.5寸、2寸 1INCH、1.5 INCH、2INCH、  
.颜色/Colour: 黑色: black  
.高度/height: 53、63、83mm



**ZD-P011-A**

.材质/Material: nylon+pu  
.规格 size: 2寸 2INCH、  
.颜色/Colour: 黑色: black

ZD-P系列



**ZD-P012**

.材质/Material: 透明 pu Transparent pu  
.规格/size: 1.5寸、2寸、3寸、4寸 1.5INCH、2INCH、3INCH、4INCH  
.高度/height: 50.5mm、64mm



**ZD-P010**

.材质/Material: 尼龙 nylon  
.规格 size: 2寸 2INCH、  
.颜色/Colour: 黑色: black



**ZD-P012-A 带刹车**

.材质/Material: 透明 pu Transparent pu  
.规格/size: 1.5寸、2寸、3寸、4寸 1.5INCH、2INCH、3INCH、4INCH  
.高度/height: 50.5mm、64mm



**ZD-P013**

.材质/Material: 橡胶 Rubber  
.规格/size: 2寸、3寸、4寸 2INCH、3INCH、4INCH



**ZD-P010-A**

.材质/Material: 尼龙 nylon  
.规格 size: 2寸 2INCH、  
.颜色/Colour: 黑色: black



**ZD-P011**

.材质/Material: nylon+pu  
.规格 size: 2寸 2INCH、  
.颜色/Colour: 黑色: black



**ZD-P014**

.材质/Material: 橡胶 Rubber  
.规格/size: 3寸、4寸 5寸 2INCH、3INCH、4INCH、5INCH



**ZD-P015**

.材质/Material: 橡胶 Rubber  
.规格/size: 1寸、1.25寸、2寸 1INCH、1.25INCH、2INCH

ZD-P系列



ZD-P016

.材质/Material: 橡胶 Rubber  
.规格/size: 2.5寸、3寸、4寸、5寸 2.5INCH、3 INCH、4INCH、5INCH



ZD-P017

.材质/Material: 橡胶 Rubber  
.规格/size: 2.5寸、3寸、4寸、5寸 2.5INCH、3 INCH、4INCH、5INCH



ZD-P022

.材质/Material: 橡胶 Rubber  
.规格/size: 3寸、4寸、5寸 3 INCH、4INCH、5INCH



ZD-P023

.材质/Material: 橡胶 Rubber  
.规格/size: 3寸、4寸、5寸 3 INCH、4INCH、5INCH



ZD-P018

.材质/Material: 橡胶 Rubber  
.规格/size: 3寸、4寸 3 INCH、4INCH



ZD-P019

.材质/Material: 橡胶 Rubber  
.规格/size: 3寸、4寸、5寸 3 INCH、4INCH、5INCH



ZD-P020

.材质/Material: 橡胶 Rubber  
.规格/size: 3寸、4寸、5寸 3 INCH、4INCH、5INCH



ZD-P021

.材质/Material: 橡胶 Rubber  
.规格/size: 3寸、4寸、5寸 3 INCH、4INCH、5INCH

ZD-P系列

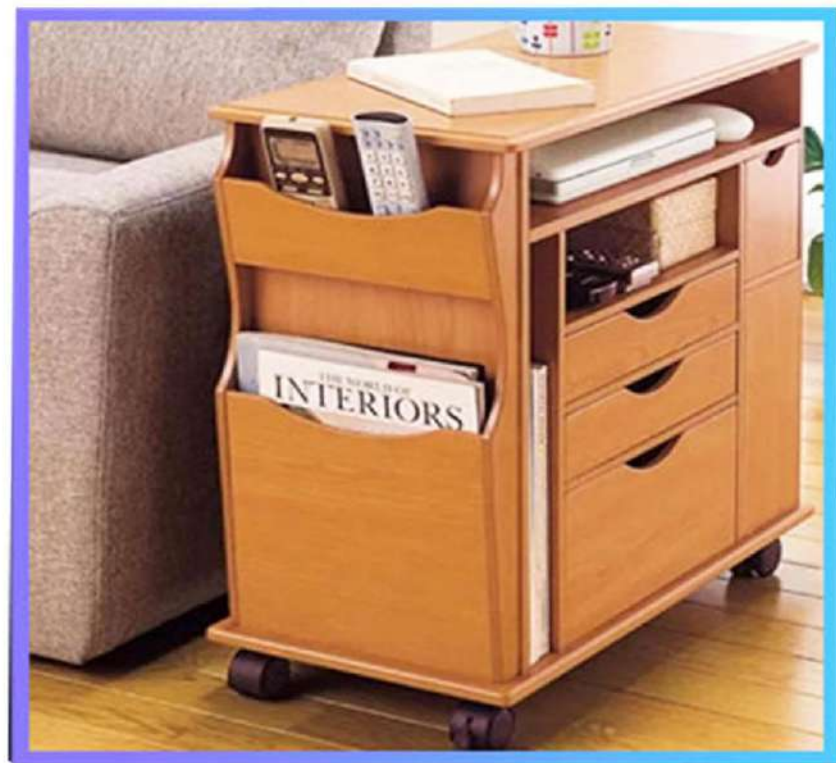



ZD-P系列

ZD-P系列



ZD-P024

.材质/Material: 橡胶 Rubber  
.规格/size: 4寸、5寸、6寸、8寸 4INCH、5INCH、6INCH、8INCH



ZD-P025

.材质/Material: 橡胶 Rubber  
.规格/size: 4寸、5寸、6寸、8寸 4INCH、5INCH、6INCH、8INCH



ZD-P026

.材质/Material: 橡胶 Rubber  
.规格/size: 4寸、5寸、6寸、8寸 4INCH、5INCH、6INCH、8INCH



ZD-P027

.材质/Material: 橡胶 Rubber  
.规格/size: 4寸、5寸、6寸、8寸 4INCH、5INCH、6INCH、8INCH



ZD-P028

.材质/Material: 橡胶 Rubber  
.规格/size: 4寸、5寸、6寸、8寸 4INCH、5INCH、6INCH、8INCH



ZD-P029

.材质/Material: 橡胶 Rubber  
.规格/size: 4寸、5寸、6寸、8寸 4INCH、5INCH、6INCH、8INCH



ZD-P030

.材质/Material: 橡胶 Rubber  
.规格/size: 4寸、5寸、6寸、8寸 4INCH、5INCH、6INCH、8INCH



ZD-P031

.材质/Material: 橡胶 Rubber  
.规格/size: 4寸、5寸、6寸、8寸 4INCH、5INCH、6INCH、8INCH



ZD-PV系列

ZD-PV系列



ZD-PV01

.材质/Material: PVC  
.表面处理/Finish: 金色 gold,  
.规格/size: 9、10、15mm、



ZD-PV02

.材质/Material: PVC  
.表面处理/Finish: 金色、银色 gold, Silver  
.规格/size: 3、5、8、12、15、18、20、25、  
30、50、70、100mm、



ZD-PV05

.材质/Material: PVC  
.规格/size: 10、15、18mm



ZD-PV06

.材质/Material: PVC  
.规格/size: 10、15、18mm

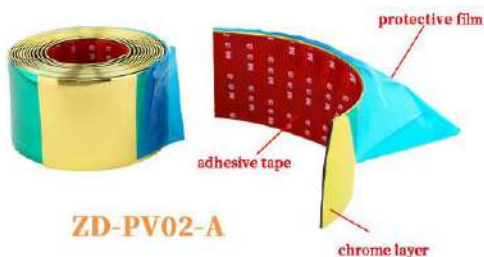

ZD-PV02-A

.材质/Material: PVC  
.表面处理/Finish: 金色、银色 gold, Silver  
.规格/size: 3、6、8、10、12、15、18、20、25、  
30、50、70、100mm、



ZD-PV07

.材质/Material: PVC  
.规格/size: 10、12、18mm



ZD-PV08

.材质/Material: PVC  
.规格/size: 15mm

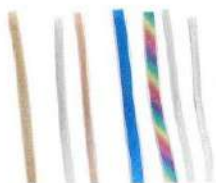

ZD-PV03

.材质/Material: PVC  
.表面处理/Finish: 金色 银色 gold, Silver  
.规格/size: 10、12、20、25mm

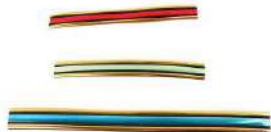

ZD-PV04

.材质/Material: PVC  
.规格/size: 10、15、18mm



ZD-PV09

.材质/Material: PVC  
.规格/size: 8、10、15、18、20、25mm



ZD-PV11-A

.材质/Material: PVC  
.规格/size: 10、12、15、20、25、35、40、  
45、55、70、100mm



ZD-PE系列



ZD-PE01

.材质/Material: PVC+塑料 PVC+plastic  
.厚度/thickness:1.0mm  
.宽度/width: 8, 12, 15, 18mm



ZD-S系列



ZD-S001

.材质/Material: SS304/0.6  
.规格/size:6\*6, 8\*6, 12\*6, 20\*8, 25\*8mm  
.长度/length:2440mm



ZD-S002

.材质/Material: SS304/0.6  
.规格/size:5\*5\*5, 8\*8\*8, 12\*12\*12, 12\*19\*12  
12\*25\*12, 12\*38\*12, 12\*50\*12, 12\*75\*12mm  
.长度/length:2440mm

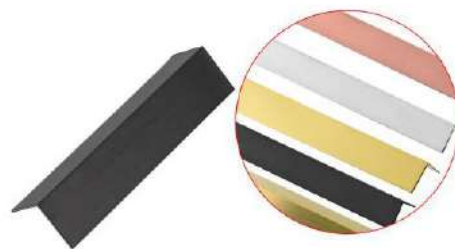

ZD-S003

.材质/Material: SS304/0.6  
.规格/size:12\*12, 19\*19, 25\*25mm  
.长度/length:2440mm



织带系列



150#A

.材质/Material: Polyethylene(PE) with Malaysia rubber  
.表面处理/Finish: 绿色 green  
.宽度/Width:50mm  
.拉力/STRETCH : 90%



250#A

.材质/Material: Polyethylene(PE) with Malaysia rubber  
.表面处理/Finish: 绿色 green  
.宽度/Width:50mm  
.拉力/STRETCH:60%



350#A

.材质/Material: Polyethylene(PE) with Malaysia rubber  
.表面处理/Finish: 绿色 green  
.宽度/Width:50mm  
.拉力/STRETCH: 45%



150#B

.材质/Material: Polyethylene(PE) with Chinese  
.表面处理/Finish: 绿色 green  
.宽度/Width:50mm  
.拉力/STRETCH: 85%



350#B

.材质/Material: Polyethylene(PE) with Chinese  
.表面处理/Finish: 绿色 green  
.宽度/Width:50mm  
.拉力/STRETCH: 45%



450#A

.材质/Material: Polyethylene(PE) with Malaysia rubber  
.表面处理/Finish: 绿色 green  
.宽度/Width:50mm  
.拉力/STRETCH:40%



250#B

.材质/Material: Polyethylene(PE) with Chinese  
.表面处理/Finish: 绿色 green  
.宽度/Width:50mm  
.拉力/STRETCH 55%



350#D

.材质/Material: Polyethylene(PE) with Chinese  
.表面处理/Finish: 绿色 green  
.宽度/Width:50mm  
.拉力/STRETCH45%

织带系列



织带系列



A450#B

.材质/Material: Polyethylene(PE) with Chinese  
.表面处理/Finish: 绿色 green  
.宽度/Width: 50mm  
.拉力/STRETCH: 45%



460#A

.材质/Material: Polyethylene(PE) with Chinese  
.表面处理/Finish: 绿色 green  
.宽度/Width: 60mm  
.拉力/STRETCH: 90%



A480#B

.材质/Material: Polyethylene(PE) with Chinese  
.表面处理/Finish: 绿色 green  
.宽度/Width: 60mm  
.拉力/STRETCH: 40%



480#S

.材质/Material: Polyethylene(PE) with Chinese  
.表面处理/Finish: 绿色 green  
.宽度/Width: 80mm  
.拉力/STRETCH: 30%



ZD-Q101

.材质/Material: 棉 cotton  
.规格/size: 2.5、3、4、5、6、7、8、9、10mm



ZD-Q102

.材质/Material: 棉 cotton  
.规格/size: 3、4、5、6、7、8、9、10mm



ZD-Q系列



ZD-Q103

.材质/Material: 棉 cotton  
.规格/size: 5、6mm  
.备注/remark: 尺寸可以订做/size can be customized



ZD-Q104(扁带)

.材质/Material: 涤纶 terylene  
.备注/remark: 尺寸可以订做/size can be customized



枪钉系列

10J 系列



肩寬: 11.20mm  
縫寬: 1.20mm  
縫厚: 0.60mm  
長度: 4-22mm  
材料: 鍍鋅鐵絲、中碳鋼、不銹鋼等

10F 系列



肩寬: 11.20mm  
縫寬: 0.75mm  
縫厚: 0.60mm  
長度: 5-15mm  
材料: 鍍鋅鐵絲、不銹鋼等

12F/23 系列



肩寬: 13.20mm  
縫寬: 0.75mm  
縫厚: 0.60mm  
長度: 5-22mm  
材料: 鍍鋅鐵絲、不銹鋼等

4J 系列



肩寬: 5.20mm  
縫寬: 1.20mm  
縫厚: 0.60mm  
長度: 4-22mm  
材料: 鍍鋅鐵絲、不銹鋼等

K 系列



肩寬: 5.70mm  
縫寬: 1.25mm  
縫厚: 1.05mm  
長度: 8-40mm  
材料: 鍍鋅鐵絲、中碳鋼、高碳鋼、不銹鋼等

角釘



肩寬: 10/11.00mm  
長度: 5, 7, 8, 10, 12, 15mm  
材料: 高強度鋼板

瓜子釘



4.5mm/5.00mm  
0.35mm-0.50mm  
肩寬: 4.5/5.00mm  
厚度: 0.35mm-0.50mm  
長度: 15mm  
材料: 鋼片

蚊釘



縫徑: 0.63/0.84mm  
長度: 6-30mm  
材料: 鍍鋅鐵絲、不銹鋼等

F 釘



縫寬: 1.25mm  
縫厚: 1.00mm  
釘頭: 2.00\*1.25mm  
長度: 5-50mm  
材料: 鍍鋅鐵絲、不銹鋼等

T 釘



縫寬: 1.60mm  
縫厚: 1.40mm  
釘頭: 3.00\*1.60mm  
長度: 15-64mm  
材料: 鍍鋅鐵絲、不銹鋼等

二浪釘



高度: 1/4", 3/8", 1/2"  
材料: 鋼片

五浪釘



肩寬: 1"  
高度: 1/4", 3/8", 1/2", 5/8"  
材料: 鋼片

扣布釘



22  
HR-22  
肩寬: 22.00mm  
高度: 12mm  
縫寬: 1.97mm  
縫厚: 1.42mm  
材料: 鍍鋅鐵絲、鍍銅鐵絲

13 系列



肩寬: 10.60mm  
縫寬: 0.70mm  
縫厚: 0.50mm  
長度: 4-14mm  
材料: 鍍鋅鐵絲

12J/P88 系列



肩寬: 13.20mm  
縫寬: 1.25mm  
縫厚: 0.50mm  
長度: 10-25mm  
材料: 鍍鋅鐵絲

35/32 系列



肩寬: 35/32mm  
縫寬: 2.28/1.95mm  
縫厚: 0.90mm  
長度: 12-22mm  
材料: 鍍鋅鐵絲、鍍銅鐵絲

枪钉系列

P 系列



肩寬: 24.80mm/26.00mm  
縫寬: 1.60mm  
縫厚: 1.40mm  
長度: 13-50mm  
材料: 鍍鋅鐵絲、中碳鋼、不銹鋼

型號	長度(mm)
P08	13
P11	19
P12	22
P13	25
P15	32
P17	38
P19	45
P21	50

N 系列



肩寬: 10.80mm/11.10mm  
縫寬: 1.60mm  
縫厚: 1.40mm  
長度: 16-50mm  
材料: 鍍鋅鐵絲、中碳鋼、不銹鋼

型號	長度(mm)
N11	16
N12	19
N13	25
N15	32
N17	38
N19	45
N21	50

夾碼釘



使用工具				
M65	4.8	12.7	CL-23	CL-73
		15.5	CL-24	CL-74
M66	6.2	12.3	CL-3	CL-71
		14.1	CL-4	CL-72

使用工具			
M45	4.8	10.7	CL-13
		9.9	CL-15
		10.0	CL-17
		11.0	CL-12
M46	6.2	12.7	CL-14
		15.0	CL-16
		13.3	CL-18

扣環釘

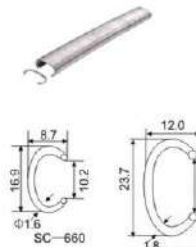

8.7  
16.9  
10.2  
SC-660  
12.0  
23.7  
13.5  
1.8  
SC-6

卷釘



15  
縫徑: 2.10-3.33mm  
長度: 25-100mm  
度數: 15°  
釘杆: 光身, 環紋或螺紋  
材料: 鐵絲

ST/HT 水泥鋼釘



縫徑: 2.20mm/1.83mm  
釘頭: 7.00x2.20mm  
長度: 15-64mm  
材料: 高碳鋼絲

四浪釘



肩寬: 1"  
高度: 3/8", 1/2"  
材料: 鋼片



枪钉系列

MA-C20N Corrugated Nails Series



inch	mm
1/4"	6.5
3/8"	9.5
1/2"	12.7



- Crown: 11/16"
- Length: 1/4", 3/8", 1/2"
- Material: Armor plate

MA-C20 Corrugated Nails Series



inch	mm
3/8"	9.5
1/2"	12.7

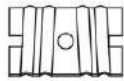

- Crown: 1"
- Length: 3/8", 1/2"
- Material: Armor plate

CF-15 Corrugated Nails Series



inch	mm
1/4"	6.5
3/8"	9.5
1/2"	12.7
5/8"	16



- Crown: 1/2"
- Length: 1/4", 3/8", 1/2", 5/8"
- Material: Armor plate

Corrugated Nails Series 1



inch	mm
1/4"	6.5
3/8"	9.5
1/2"	12.7

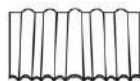

- Crown: 1"
- Length: 1/4", 3/8", 1/2"
- Material: Armor plate

Corrugated Nails Series 2



inch	mm
1/4"	6.5
3/8"	9.5
1/2"	12.7



- Crown: 1"
- Length: 1/4", 3/8", 1/2"
- Material: Armor plate

枪钉系列

F Brads Series

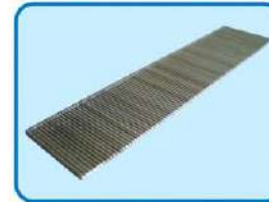

inch	mm
3/8"	10
5/8"	15
13/16"	20
1"	25
1-3/16"	30
1-3/8"	35
1-9/16"	40
1-3/4"	45
2"	50



- Gauge: 18
- Width: 1.25mm
- Thickness: 1.00mm
- Head: 2.00mm×1.25mm
- Length: 5mm-50mm
- Material: Zinc Plating Wire  
Copper Wire  
Stainless Wire  
Steel Wire

T Brads Series

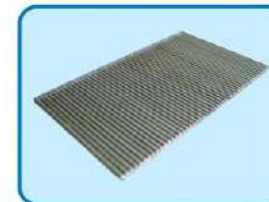

inch	mm
1"	25
1-1/4"	32
1-1/2"	38
1-3/4"	45
2"	50
2-1/4"	57
2-1/2"	64



- Gauge: 16
- Width: 1.60mm
- Thickness: 1.40mm
- Head: 3.00mm×1.60mm
- Length: 16mm-64mm
- Material: Zinc Plating Wire  
Copper Wire  
Stainless Wire  
Steel Wire

ST/HT Brads Series

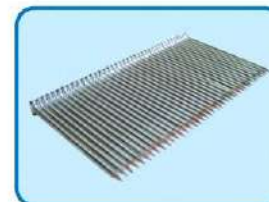

inch	mm
3/4"	18
1"	25
1-1/4"	32
1-1/2"	38
1-3/4"	45
2"	50
2-1/4"	57
2-1/2"	64



- Gauge: 13
- Diameter: 2.20mm
- Head: 7.00mm×2.20mm
- Length: 15mm-64mm
- Material: Steel Wire

C Hog Ring Series

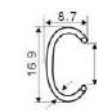

SC-660

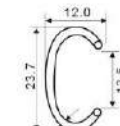

SC-6

- Gauge: 16/15
- Diameter: 1.6mm/1.8mm
- Crown: 16.9mm/23.7mm
- Length: 8.7mm/12mm
- Material: Zinc Plating Wire  
Stainless Wire

F-ST Brads Series



inch	mm
5/8"	15
3/4"	18
13/16"	20
1"	25
1-3/16"	30
1-3/8"	35
1-9/16"	40
1-3/4"	45
2"	50



- Gauge: 15
- Diameter: 1.83mm
- Head: 3.00mm×1.83mm
- Length: 15mm-50mm
- Material: Steel Wire

DA Oblique Brads Series



inch	mm
1-1/2"	38
1-3/4"	45
2"	50
2-1/4"	57
2-1/2"	64

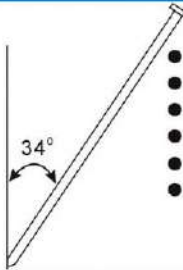

- Gauge: 15
- Diameter: 1.84mm
- Head: 3.00mm×1.83mm
- Length: 38mm-64mm
- Degree: 34°
- Material: Steel Wire

Plastic Strip Brads Series



inch	mm
2-3/16"	55
2-3/8"	60
2-1/2"	65
2-3/4"	70
3"	75
3-1/4"	83
3-9/16"	90



- Diameter: 2.87mm/3.33mm
- Length: 55mm-90mm
- Degree: 21°
- Shank: Smooth, Screw, ring
- Material: Iron Wire

Paper Strip Brads Series



inch	mm
2-3/16"	55
2-3/8"	60
2-1/2"	65
2-3/4"	70
3"	75
3-1/4"	83
3-9/16"	90

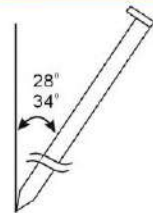

- Diameter: 2.87mm/3.33mm
- Length: 55mm-90mm
- Degree: 28°/34°
- Shank: Smooth, Screw, ring
- Material: Iron Wire

Headless Mini Pins Series



inch	mm
5/16"	8
3/8"	10
1/2"	12
5/8"	15
3/4"	18
13/16"	20
7/8"	22
1"	25
1-3/16"	30



- Gauge: 23/21
- Diameter: 0.63mm/0.84mm
- Length: 6mm-30mm
- Material: Zinc Plating Wire  
Copper Plating Wire  
Stainless Wire

4J Staples Series

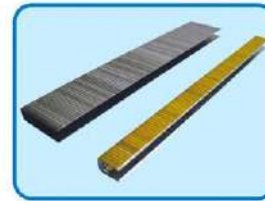

inch	mm
5/32"	4
1/4"	6
5/16"	8
3/8"	10
17/32"	13
5/8"	16
3/4"	19
7/8"	22



- Gauge: 20
- Crown: 5.20mm
- Width: 1.20mm
- Thickness: 0.60mm
- Length: 4mm-22mm
- Material: Zinc Plating Wire  
Copper Wire  
Stainless Wire  
Steel Wire

10J Staples Series

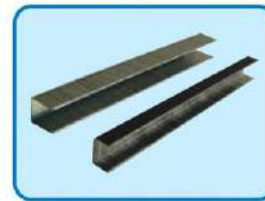

inch	mm
5/32"	4
1/4"	6
5/16"	8
3/8"	10
17/32"	13
5/8"	16
3/4"	19
7/8"	22



- Gauge: 20
- Crown: 11.20mm
- Width: 1.20mm
- Thickness: 0.60mm
- Length: 4mm-22mm
- Material: Zinc Plating Wire  
Copper Wire  
Stainless Wire

12J(88) Staples Series (Mattress Nails)

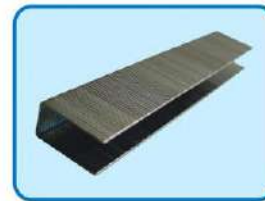

inch	mm
3/8"	10
1/2"	12
5/8"	16
3/4"	18
13/16"	20
7/8"	22
1"	25



- Gauge: 20
- Crown: 13.20mm
- Width: 1.25mm
- Thickness: 0.50mm
- Length: 10mm-25mm
- Material: Zinc Plating Wire  
Copper Wire  
Stainless Wire



枪钉系列

枪钉系列

50 Staples Series

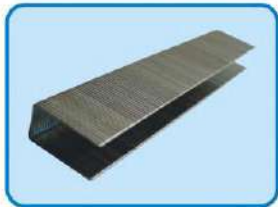

inch	mm
1/8"	3
5/32"	4
3/16"	5
1/4"	6
5/16"	8
3/8"	10
1/2"	12
9/16"	14
5/8"	16



- Gauge: 20
- Crown: 12.50mm
- Width: 1.25mm
- Thickness: 0.50mm
- Length: 3mm-16mm
- Material: Zinc Plating Wire  
Copper Wire  
Stainless Wire

10×8F Staples Series

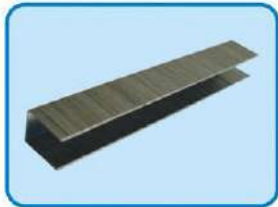

inch	mm
1/4"	6
5/16"	8



- Gauge: 22
- Crown: 10.40mm
- Width: 0.75mm
- Thickness: 0.60mm
- Length: 6mm/8mm
- Material: Zinc Plating Wire

10F Staples Series

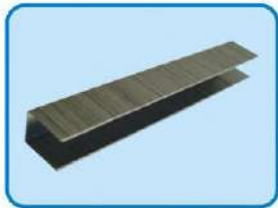

inch	mm
3/16"	5
9/32"	7
3/8"	10
17/32"	13
5/8"	16



- Gauge: 22
- Crown: 11.20mm
- Width: 0.75mm
- Thickness: 0.60mm
- Length: 5mm-16mm
- Material: Zinc Plating Wire

M Mattress Nails Series



Tool	4.8	6.2	8.0	10.0
M65	12.7 15.5	CL-23 CL-24	CL-73 CL-74	
M66	12.3 14.1	CL-3 CL-4	CL-71 CL-72	

Tool	4.8	6.2	8.0	10.0
M45	10.7	CL-13		
	9.9	CL-15		
	10.0	CL-17		
M46	11.0	CL-12		
	12.7	CL-14		
	15.0	CL-16		
	13.3	CL-18		

12F Staples Series

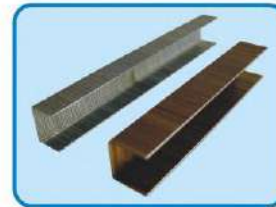

inch	mm
3/16"	5
9/32"	7
3/8"	9
1/2"	12
5/8"	15
3/4"	18
7/8"	22



- Gauge: 22
- Crown: 13.20mm
- Width: 0.75mm
- Thickness: 0.60mm
- Length: 5mm-22mm
- Material: Zinc Plating Wire

80 Staples Series

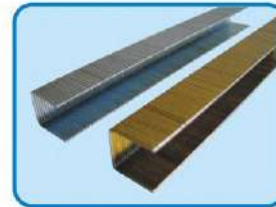

inch	mm
5/32"	4
1/4"	6
5/16"	8
3/8"	10
1/2"	12
9/16"	14
5/8"	16



- Gauge: 21
- Crown: 12.80mm
- Width: 0.95mm
- Thickness: 0.65mm
- Length: 4mm-16mm
- Material: Zinc Plating Wire

84 Staples Series

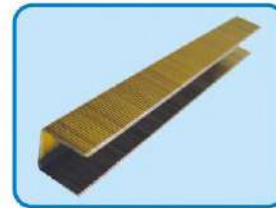

inch	mm
5/32"	4
1/4"	6
5/16"	8
3/8"	10
1/2"	12
9/16"	14
5/8"	16



- Gauge: 21
- Crown: 12.30mm
- Width: 1.00mm
- Thickness: 0.55mm
- Length: 4mm-16mm
- Material: Zinc Plating Wire

71 Staples Series

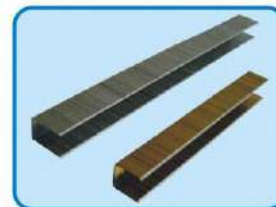

inch	mm
1/4"	6
5/16"	8
3/8"	10
1/2"	12
9/16"	14
5/8"	16



- Gauge: 22
- Crown: 9.00mm
- Width: 0.75mm
- Thickness: 0.60mm
- Length: 6mm-16mm
- Material: Zinc Plating Wire

### 14 Staples Series

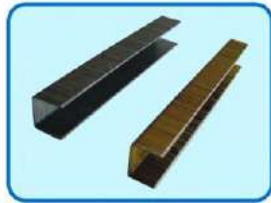

inch	mm
5/32"	4
1/4"	6
5/16"	8
3/8"	10
1/2"	12
9/16"	14



- Gauge: 22
- Crown: 10.10mm
- Width: 0.75mm
- Thickness: 0.60mm
- Length: 4mm-14mm
- Material: Zinc Plating Wire

### 64 Staples Series

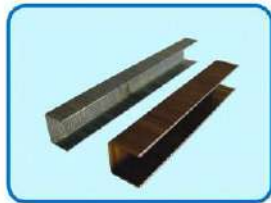

inch	mm
5/32"	4
1/4"	6
5/16"	8
3/8"	10
1/2"	12
9/16"	14
5/8"	16



- Gauge: 22
- Crown: 12.50mm
- Width: 0.75mm
- Thickness: 0.60mm
- Length: 4mm-16mm
- Material: Zinc Plating Wire

### 90(K) Staples Series

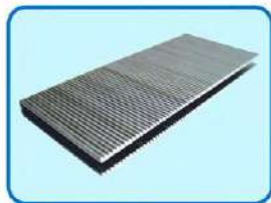

inch	mm
13/16"	20
7/8"	22
1"	25
1-1/8"	28
1-3/16"	30
1-3/8"	35
1-9/16"	40



- Gauge: 18
- Crown: 5.70mm
- Width: 1.25mm
- Thickness: 1.05mm
- Length: 8mm-40mm
- Material: Zinc Plating Wire  
Stainless Wire  
Steel Wire

### 92 Staples Series

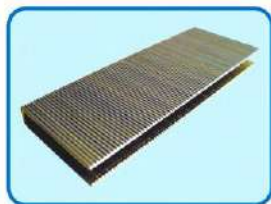

inch	mm
13/16"	20
7/8"	22
1"	25
1-1/8"	28
1-3/16"	30
1-3/8"	35
1-9/16"	40



- Gauge: 18
- Crown: 8.70mm
- Width: 1.25mm
- Thickness: 1.05mm
- Length: 9mm-50mm
- Material: Zinc Plating Wire  
Stainless Wire

### 8N(100) Staples Series

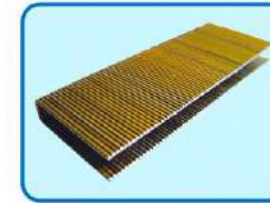

inch	mm
7/8"	22
1"	25
1-1/8"	28
1-1/4"	32
1-1/2"	38
1-3/4"	45
2"	50



- Gauge: 16
- Crown: 10.80mm/11.10mm
- Width: 1.60mm
- Thickness: 1.40mm
- Length: 19mm-50mm
- Material: Zinc Plating Wire  
Stainless Wire

### 9N Staples Series

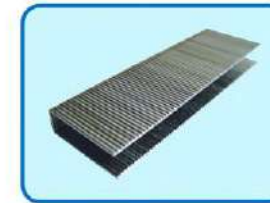

inch	mm
7/8"	22
1"	25
1-1/8"	28
1-1/4"	32
1-1/2"	38
1-3/4"	45
2"	50



- Gauge: 16
- Crown: 12.30mm
- Width: 1.60mm
- Thickness: 1.40mm
- Length: 22mm-50mm
- Material: Zinc Plating Wire  
Stainless Wire

### Q Staples Series

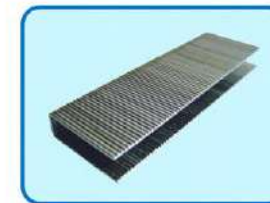

inch	mm
1-1/4"	32
1-1/2"	38
1-3/4"	45
2"	50
2-1/4"	57
2-1/2"	64



- Gauge: 15
- Crown: 11.10mm
- Width: 1.90mm
- Thickness: 1.60mm
- Length: 32mm-64mm
- Material: Zinc Plating Wire

### SB Staples Series

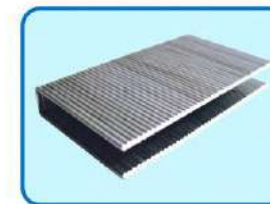

inch	mm
1-3/4"	45
2"	50
2-3/16"	55
2-3/8"	60
2-1/2"	65
2-3/4"	70
3"	75



- Gauge: 15
- Crown: 12.60mm
- Width: 1.90mm
- Thickness: 1.60mm
- Length: 40mm-75mm
- Material: Zinc Plating Wire



**P Staples Series**

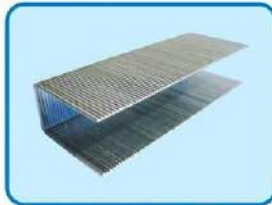

inch	mm
5/8"	16
3/4"	19
7/8"	22
1"	25
1-1/8"	28
1-1/4"	32
1-1/2"	38

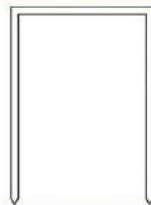

- Gauge: 16
- Crown: 24.80mm/26.00mm
- Width: 1.60mm
- Thickness: 1.40mm
- Length: 13mm-38mm
- Material: Zinc Plating Wire

**32/35 Packing Staples Series**

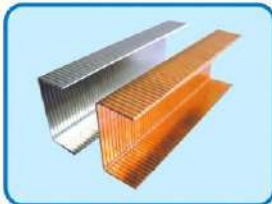

inch	mm
5/8"	15
5/8"	16
3/4"	18
7/8"	22



- Gauge: 16
- Crown: 32.00mm/35.00mm
- Width: 1.95mm/2.28mm
- Thickness: 0.9mm
- Length: 12mm-22mm
- Material: Zinc Plating Wire  
Copper Plating Wire

**Roll Packing Staples Series 1**

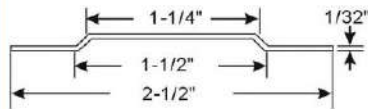

- Gauge: 16
- Crown: 32.00mm
- Width: 1.95mm
- Thickness: 0.9mm
- Length: 16mm
- Material: Copper Plating Wire

**Roll Packing Staples Series 2**

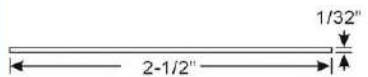

- Gauge: 16
- Crown: 32.00mm
- Width: 1.95mm
- Thickness: 0.9mm
- Length: 16mm
- Material: Copper Plating Wire

**Packing Wire**



- Gauge: 18
- Width: 2.20mm
- Thickness: 0.45mm
- Material: Copper Plating Wire

**Roofing Coil nail**



inch	mm
7/8"	22
1"	25
1-1/4"	32
1-1/2"	38
1-3/4"	45
2"	50



- Diameter: 2.10mm-3.33mm
- Length: 25mm-100mm
- Degree: 16°
- Shank: Smooth
- Material: Zinc Plating Wire

**Coil nails Series**



inch	mm
1"	25
1-1/4"	32
1-1/2"	38
1-3/4"	45
2"	50
2-1/2"	64
3"	75
3-1/4"	83
3-9/16"	90
4"	100



- Diameter: 3.05mm
- Length: 22mm-45mm
- Degree: 16°
- Shank: Smooth, Screw, Ring
- Material: Steel Wire

**Frame Sheet nails Series**

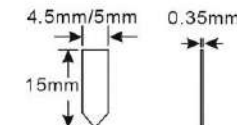

- Crown: 4.5mm/5.0mm
- Thickness: 0.35mm
- Length: 15mm
- Material: Armor plate  
Copper plate

**Frame V-nail Series**

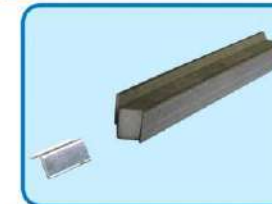

inch	mm
3/16"	5
9/32"	7
5/16"	8
3/8"	10
1/2"	12
5/8"	15



- Crown: 10mm/11mm
- Length: 5, 7, 8, 10, 12, 15mm
- Material: Armor plate

**HR-22 Hog ring Nails Series (Mattress Nails)**

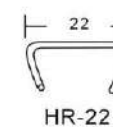

- Gauge: 15
- Crown: 22.00mm
- High: 12mm
- Width: 1.97mm
- Thickness: 1.42mm
- Material: Zinc Plating Wire  
Copper Plating Wire

ZD-SC系列



ZD-SC01 波浪头

.材质/Material: 铁 iron  
.表面处理/Finish: 镀彩锌 color zinc plated  
.规格/size: M8\*31mm



ZD-SC02 倒边十字白铁

.材质/Material: 铁 iron  
.表面处理/Finish: 镀彩锌/镀白锌 color zinc plated /white zinc plated  
.规格/size: M5\*30, M5\*40, M5\*50, M5\*60



ZD-SC03-A 双头牙单头尖

.材质/Material: 铁 iron  
.表面处理/Finish: 镀彩锌 color zinc plated  
.规格/size: M8\*70, M8\*75, M8\*90, M8\*100 mm

ZD-SC系列



ZD-SC03-B 双头牙双头尖中间打扁

.材质/Material: 铁 iron  
.表面处理/Finish: 镀白锌 white zinc plated  
.规格/size: M6\*60, M6\*80 mm



ZD-SC04 大扁头十字

.材质/Material: 铁 iron  
.表面处理/Finish: 镀白锌 white zinc plated  
.规格/size: M4\*20, M4\*25, M4\*30



ZD-SC05 木牙十字

.材质/Material: 铁 iron  
.表面处理/Finish: 镀彩锌/镀白锌 color zinc plated /white zinc plated  
.规格/size: M6\*40, M6\*50mm



ZD-SC06 木牙十字

.材质/Material: 铁 iron  
.表面处理/Finish: 镀彩锌/镀白锌 color zinc plated /white zinc plated  
.规格/size: M6\*40, M6\*50mm



ZD-SC07 打墙钉

.材质/Material: 铁 iron  
.表面处理/Finish: 黑色/镀彩锌/镀白锌 black / color zinc plated /white zinc plated  
.规格/size: M5\*30, M5\*40, M5\*50, M5\*70 mm



ZD-SC系列



**ZD-SC08 快螺牙**

.材质/Material: 铁 iron  
.表面处理/Finish: 黑色/镀彩锌/镀白锌 black / color zinc plated /white zinc plated  
.规格/size: M4\*15、M4\*20、M4\*30、M4\*60、M4\*69mm



**ZD-SC09 防滑螺母**

.材质/Material: 铁 iron  
.表面处理/Finish: 镀彩锌/镀白锌 color zinc plated /white zinc plated  
.规格/size: M6、M8、M14、M20



**ZD-SC11 内外牙沉头**

.材质/Material: 铁 iron  
.表面处理/Finish: 镀彩锌 color zinc plated  
.规格/size: M6\*10、M6\*12、M6\*13、M6\*15、M6\*17、M6\*20、M6\*25



**ZD-SC12 螺母**

.材质/Material: 铁 iron  
.表面处理/Finish: 镀彩锌/镀白锌 color zinc plated /white zinc plated  
.规格/size: M5、M8、M10、M14



**ZD-SC10 内外牙直螺**

.材质/Material: 铁 iron  
.表面处理/Finish: 镀彩锌/镀白锌 color zinc plated /white zinc plated  
.规格/size: M6\*15、M6\*17、M6\*20mm



**ZD-SC13 铁皮内爪螺母**

.材质/Material: 铁 iron  
.表面处理/Finish: 镀白锌 white zinc plated  
.规格/size: M5\*H10mm



**ZD-SC14 铁皮内爪螺母**

.材质/Material: 铁 iron  
.表面处理/Finish: 镀彩锌/镀白锌 color zinc plated /white zinc plated  
.规格/size: M5\*H10、M5\*12、M5\*20mm



**ZD-SC16 六角匙**

.材质/Material: 铁 iron  
.表面处理/Finish: 镀彩锌/镀白锌 color zinc plated /white zinc plated  
.规格/size: M4、M5、M6、M8

ZD-H1系列



ZD-H101

.材质/Material: 锌合金 Zinc alloy  
.表面处理/Finish: 蓝色、银色、红古铜、青铜色 Blue, silver, red bronze, bronze  
.高度/height: 22mm  
.长度/length: 170mm



ZD-H103

.材质/Material: 锌合金 Zinc alloy  
.表面处理/Finish: 蓝色、银色、红古铜、青铜色、灰色 Blue, silver, red bronze, bronze, Gray  
.高度/height: 22mm  
.长度/length: 170mm



ZD-H105

.材质/Material: 锌合金 Zinc alloy  
.表面处理/Finish: 宝蓝色 royalblue  
.高度/height: 32、51mm  
.长度/length: 150mm



ZD-H102(前)

.材质/Material: 锌合金 Zinc alloy  
.表面处理/Finish: 蓝色、银色、红古铜、青铜色 Blue, silver, red bronze, bronze  
.高度/height: 50mm  
.长度/length: 170mm



ZD-H104(后)

.材质/Material: 锌合金 Zinc alloy  
.表面处理/Finish: 蓝色、银色、红古铜、青铜色、灰色 Blue, silver, red bronze, bronze, Gray  
.高度/height: 50mm  
.长度/length: 170mm



ZD-H106

.材质/Material: 锌合金 Zinc alloy  
.表面处理/Finish: 灰色 Gray  
.高度/height: 26、45mm  
.长度/length: 165mm

ZD-H1系列





ZD-H2系列



**ZD-H201** (320氧化拉手)

.材质/Material: 铝 aluminum  
.表面处理/Finish: 金色、银色、黑色 Gold, silver, black  
.孔距/The distance of the hole: 285mm



**ZD-H202** (320小方氧化拉手)

.材质/Material: 铝 aluminum  
.表面处理/Finish: 金色、银色、黑色 Gold, silver, black  
.孔距/The distance of the hole: 282mm



**ZD-H206** (400小方氧化拉手)

.材质/Material: 铝 aluminum  
.表面处理/Finish: 金色、银色、黑色 Gold, silver, black  
.孔距/The distance of the hole: 368mm



**ZD-H207** (400菱形氧化拉手)

.材质/Material: 铝 aluminum  
.表面处理/Finish: 金色、银色、黑色 Gold, silver, black  
.孔距/The distance of the hole: 361mm



**ZD-H203** (350氧化拉手)

.材质/Material: 铝 aluminum  
.表面处理/Finish: 金色、银色、黑色 Gold, silver, black  
.孔距/The distance of the hole: 315mm



**ZD-H208** (430氧化拉手)

.材质/Material: 铝 aluminum  
.表面处理/Finish: 金色、银色、黑色 Gold, silver, black  
.孔距/The distance of the hole: 400mm



**ZD-H209** (600方氧化拉手)

.材质/Material: 铝 aluminum  
.表面处理/Finish: 金色、银色、黑色 Gold, silver, black  
.孔距/The distance of the hole: 550mm



**ZD-H204** (390氧化拉手)

.材质/Material: 铝 aluminum  
.表面处理/Finish: 金色、银色、黑色 Gold, silver, black  
.孔距/The distance of the hole: 350mm



**ZD-H205** (400大方氧化拉手)

.材质/Material: 铝 aluminum  
.表面处理/Finish: 金色、银色、黑色 Gold, silver, black  
.孔距/The distance of the hole: 350mm



**ZD-H209** (630氧化拉手)

.材质/Material: 铝 aluminum  
.表面处理/Finish: 金色、银色、黑色 Gold, silver, black  
.孔距/The distance of the hole: 550mm



ZD-DL系列



**ZD-DL103**

.材质/Material: 锌铁合金 Zinc iron alloy  
.规格/size: D19\*L16, D19\*L20, D19\*L25, D19\*L30mm



**ZD-DL105-22/32**

.材质/Material: 锌铁合金 Zinc iron alloy  
.规格/size: D19\*L122, D19\*L32mm



**ZD-DL136-22**

.材质/Material: 锌合金 Zinc alloy  
.规格/size: D16\*L22 mm



**ZD-DL136-22AC**

.材质/Material: 锌铁合金 Zinc iron alloy  
.规格/size: D16\*L22 mm



**ZD-DL106-22**

.材质/Material: 锌合金 Zinc alloy  
.规格/size: D22\*L22 mm



**ZD-DL106-22B**

.材质/Material: 锌合金+铁+塑料 Zinc alloy+Iron+Plastics  
.规格/size: D21\*L24mm



**ZD-DL136-22C**

.材质/Material: 锌铁合金 Zinc iron alloy  
.规格/size: D16\*L22 mm



**ZD-DL137-22/32**

.材质/Material: 锌铁合金 Zinc iron alloy  
.规格/size: D17\*L22, D17\*L32 mm



**ZD-DL106-22C**

.材质/Material: 锌铁合金 Zinc iron alloy  
.规格/size: D22\*L22 mm



**ZD-DL109-16/19**

.材质/Material: 锌铁合金 Zinc iron alloy  
.规格/size: D16\*L22, D19\*L22 mm



**ZD-DL138-22/32**

.材质/Material: 锌铁合金 Zinc iron alloy  
.规格/size: D19\*L122, D19\*L32mm



**ZD-DL138-22AC**

.材质/Material: 锌铁合金 Zinc iron alloy  
.规格/size: D19\*L22mm



ZD-DL系列



**ZD-DL138-22P/22/32C**

.材质/Material: 铁+塑料、锌合金铁 Iron plastic, Zinc alloy iron  
.规格/size: D19\*L22、D19\*L32mm



**ZD-DL139-22-32**

.材质/Material: 锌合金 Zinc alloy  
.规格/size: D19\*L22、D19\*L32 mm



**ZD-DL338-22/32**

.材质/Material: 锌合金 Zinc alloy  
.规格/size: D19\*L22、D19\*L22mm



**ZD-DL505**

.材质/Material: 锌铁合金 Zinc alloy iron  
.规格/size: D19\*L22



**ZD-DL139-22C/32C**

.材质/Material: 锌铁合金 Zinc iron alloy  
.规格/size: D19\*L22、D19\*L32 mm



**ZD-DL202-22**

.材质/Material: 锌合金 Zinc alloy  
.规格/size: D19\*L22mm



**ZD-DL318**

.材质/Material: 锌铁合金 Zinc iron alloy  
.规格/size: D19\*L19 mm



**ZD-DL328C**

.材质/Material: 锌铁合金 Zinc iron alloy  
.规格/size: D17.5\*L19 mm

ZD-DL系列



ZD-DK系列



ZD-DKC3

- .材质/Material: 铁
- .开启角度/Opening Angled:110°
- .铰杯深度/Depth of hinge cup:11.3mm(9.5mm)
- .铰杯直径/Diameter of hinge cup : 35mm
- .面板尺寸/door dimension :3~7mm
- .门可选用板厚/Range of door thickness:14~23mm



ZD-DKCT135

- .材质/Material: 铁
- .铰杯深度/Depth of hinge cup:11.3mm
- .铰杯直径/Diameter of hinge cup : 35mm
- .面板尺寸/door dimension :3~7mm
- .门可选用板厚/Range of door thickness:12~26mm



ZD-DKFT90

- .材质/Material: 铁
- .铰杯深度/Depth of hinge cup:11.3mm
- .铰杯直径/Diameter of hinge cup : 35mm
- .面板尺寸/door dimension :3~7mm
- .门可选用板厚/Range of door thickness:12~26mm



ZD-DKG3

- .材质/Material: 铁
- .开启角度/Opening Angled:110°
- .铰杯深度/Depth of hinge cup:11.3mm(9.5mm)
- .铰杯直径/Diameter of hinge cup : 35mm
- .面板尺寸/door dimension :3~7mm
- .门可选用板厚/Range of door thickness:14~23mm



ZD-DKE3

- .材质/Material: 铁
- .开启角度/Opening Angled:110°
- .铰杯深度/Depth of hinge cup:11.3mm(9.5mm)
- .铰杯直径/Diameter of hinge cup : 35mm
- .面板尺寸/door dimension :3~7mm
- .门可选用板厚/Range of door thickness:14~23mm



ZD-DKE3PP

- .材质/Material: 铁
- .开启角度/Opening Angled:110°
- .铰杯深度/Depth of hinge cup:11.3mm(9.5mm)
- .铰杯直径/Diameter of hinge cup : 35mm
- .面板尺寸/door dimension :3~7mm
- .门可选用板厚/Range of door thickness:14~23mm



ZD-DKF3

- .材质/Material: 铁
- .开启角度/Opening Angled:110°
- .铰杯深度/Depth of hinge cup:11.3mm(9.5mm)
- .铰杯直径/Diameter of hinge cup : 35mm
- .面板尺寸/door dimension :3~7mm
- .门可选用板厚/Range of door thickness:14~23mm



ZD-DKFT45

- .材质/Material: 铁
- .铰杯深度/Depth of hinge cup:11.3mm
- .铰杯直径/Diameter of hinge cup : 35mm
- .面板尺寸/door dimension :3~7mm
- .门可选用板厚/Range of door thickness:12~26mm





ZD-MG系列



**ZD-MG-003**

.材质:Plastic 塑料  
.表面处理/Finish: grey 灰色  
.弹力/Opening force: 12N



**ZD-MG-004**

.材质:Plastic 塑料  
.表面处理/Finish: grey 灰色  
.弹力/Opening force: 14N



**ZD-MG-010**

.材质:Plastic 塑料  
.表面处理/Finish: grey/ white 灰色/白色  
.弹力/Opening force: 20N

ZD-MG系列



**ZD-MG-11款-20牛**

.材质:Plastic 塑料  
.表面处理/Finish: grey/ white 灰色/白色  
.弹力/Opening force: 20N



**ZD-MG-005**

.材质:Plastic 塑料  
.表面处理/Finish: grey 灰色  
.弹力/Opening force: 12N



**ZD-MG-005B**

.材质:Plastic 塑料  
.表面处理/Finish: grey/ white 灰色/白色  
.弹力/Opening force: 12N



**ZD-MG-011**

.材质:Plastic 塑料  
.表面处理/Finish: grey/ white 灰色/白色  
.弹力/Opening force: 20N



**ZD-MG-011B**

.材质:Plastic 塑料  
.表面处理/Finish: grey/ white 灰色/白色  
.弹力/Opening force: 20N



**ZD-MG-009**

.材质:Plastic 塑料  
.表面处理/Finish: grey/ white 灰色/白色  
.弹力/Opening force: 20N



**ZD-MG-009B**

.材质:Plastic 塑料  
.表面处理/Finish: grey/ white 灰色/白色  
.弹力/Opening force: 20N



**ZD-MG-012**

.材质:Plastic 塑料  
.表面处理/Finish: grey/ white 灰色/白色  
.弹力/Opening force: 20N

ZD-MG系列



**ZD-MG-012B**

.材质: Plastic 塑料  
.表面处理/Finish: grey/ white 灰色/白色  
.弹力/Opening force: 20N



**ZD-MG-013**

.材质: Plastic 塑料  
.表面处理/Finish: grey/ white 灰色/白色  
.弹力/Opening force: 20N



**ZD-MG-013B**

.材质: Plastic 塑料  
.表面处理/Finish: grey/ white 灰色/白色  
.弹力/Opening force: 20N



**ZD-DC001**

.材质: Aluminium+Plastic 铝+塑料  
.表面处理/Finish: Gold / Silver 金色/银色  
.弹力/Opening force: 20N



**ZD-DC002**

.材质: Aluminium+Plastic 铝+塑料  
.表面处理/Finish: Gold / Silver 金色/银色  
.弹力/Opening force: 20N



**ZD-DC006**

.材质: Plastic 塑料  
.表面处理/Finish: grey/ white 灰色/白色  
.弹力/Opening force: 14、16N



**ZD-DC007**

.材质: Stainless steel+Plastic 不锈钢+塑料  
.表面处理/Finish: grey 灰色  
.弹力/Opening force: 16N



**ZD-DC008**

.材质: Stainless steel+Plastic 不锈钢+塑料  
.表面处理/Finish: grey 灰色  
.弹力/Opening force: 16N



**ZD-DC055**

.材质: Aluminium+Plastic 铝+塑料  
.表面处理/Finish: Gold / Silver 金色/银色  
.弹力/Opening force: 20N

